

PATTERN AND INFORMATION BOOK

2018 Edition

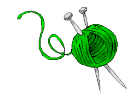

ORGANIZATION INFORMATION

Care Wear Volunteers, Inc.

Bonnie Hagerman, Founder & President

Mailing Address:

102 Mercer Court #23-5
Frederick, MD 21701-4070

Office Location: (no mailbox)

324 West Patrick Street
Frederick, MD 21701

TELEPHONE & FAX: 301-620-2858

E-MAIL: carewear@comcast.net

WEBSITE: <http://www.carewear.org>

Care Wear Volunteers, Inc., is an IRS-approved 501(c)3 nonprofit organization.
[EIN # 52-2137470]



Patterns: You will find this Pattern Book and additional patterns on the website.

Newsletters: You will find all of our quarterly newsletters posted on the website. Each issue contains patterns, photos, hospital updates, & general information. If you cannot download and print newsletters, request being added to the mailing list for a hardcopy. (carewear@comcast.net or 301-620-2858)

Hospital Information: You will find a directory of hospitals that request donated items—with name, address, contact information, and list of needs—on our website. Contact the hospital to confirm needs & address.

Donations: Care Wear Volunteers appreciates donations of fabric, yarn, wedding gowns (for our burial garment project) & other supplies and notions. Cash donations to help with printing and postage costs are very much appreciated. You will receive a receipt for all donations.

I expect to pass through this world but once; any good thing therefore that I can do, or any kindness that I can show to any fellow-creature, let me do it now; let me not defer or neglect it, for I shall not pass this way again."

PROJECT OPTIONS

KNITTING &/or CROCHET

Hats (preemie, full-term, & child)
Booties (preemie & full-term)
Mittens (preemie)
Bed socks (child & teen sizes)
Blankets (all sizes)
Finger Puppets
Sweaters
Buntings/Sacques
Lap Blankets
Shawls
Toys stuffed with fiberfill
Bereavement garments (all sizes):
 (gowns, sacques, wraps, etc.)
Chemo Hats (children-adult)
Edgings on flannel blankets
Bibs
Burp Cloths
Tote Bags for children & cancer patients
Twiddle Muffs
IV Covers for adults & children

SEWING/CRAFTS

Hats (preemie, full-term, & child)
Bibs
Preemie Kimonos w/Velcro at shoulder
Fabric/Fiberfill Toys
Diaper shirts (full-term)
Flannel Receiving Blankets
Fleece Blankets
Quilts (30" x 30" and larger)
Booties (preemie & full-term)
Incubator Covers:
 (32" x 22" Check size with hospital)
Bereavement Garments (all sizes)
 (gowns, sacques, wraps, etc.)
Burp Cloths
Flannel Mattress Covers (30" x 30" or larger)
Felt finger puppets
Hand Puppets
Medical/Surgical Learning Dolls
Hospital gowns for Medical/Surgical Dolls
Chemo hats
Walker-Caddies
Surgical/Cough pillows
Cuddle Covers
Share Squares
Lap blankets
Twiddle Muffs and Alzheimer's Aprons
Tote Bags for children & cancer patients
Neck Pillows
Fleece Shawls for cancer patients



GENERAL INFORMATION

Care Wear Volunteers items are given FREE to infants, children & their parents. Families often keep the items as a memento--especially garments for tiny preemies. Although the focus of Care Wear's efforts was originally premature infants, it has been impossible to ignore the requests for assistance for larger infants, children, & even geriatric patients. There is the most demand for the larger preemie & full-term sizes of hats & booties. Most hospitals welcome blankets and quilts. Feel free to vary colors with the season & use patterns you have & enjoy making. Please refer to the Care Wear website: (<http://www.carewear.org>) *Hospital List* for items requested.

PLEASE contact hospitals directly to confirm their needs & to confirm their mailing address. Hospitals that are not familiar with Care Wear will find it easier to respond to samples in each size. I recommend that you bring or send one of each size item that you construct. Label each with size & name of item. For example, kimono-small, kimono-medium, kimono-large. Then, the hospital can respond, "Yes, we can use kimonos in medium & large, but not small."



Send your completed items directly to the hospitals. Be sure to use the complete address & the title of the liaison person on each package. Enclose your items in plastic bags or line the box with a plastic trash bag to prevent water damage. There is no need to package each item individually. I encourage you to attach a small Care Wear Volunteers label—with your name—to each donated item. Please enclose one large Care Wear label with your full name & address in each delivery. Some of the hospitals will send personal replies to acknowledge every shipment--large or small. Others do not. I suspect that staff members are busy with urgent life-saving efforts. In some cases, your items are divided among several departments & the recipient may not know who sent the lovely hats & booties. Enclosing a self-addressed stamped postcard or envelope may help ensure a reply. In any case, don't let the lack of a response discourage you. Your efforts are greatly appreciated. (Note: Send finished items elsewhere if you NEVER receive even a brief acknowledgment of receipt.)

As more & more people learn of the needs of neonatal intensive care units (NICUs), some hospitals may be "flooded" with very tiny hats. PLEASE make hats in a range of sizes, as well as blankets, mittens, &/or burial garments. There are full-term infants in NICUs, too. PLEASE contact your local hospital to learn what is needed. Chat with the Director of Volunteers, the Director of Child Life, the Nurse Manager of the Nursery or NICU, ICN, or Special Care Nursery, or the Director of Pediatrics. You might want to use these patterns to make hats & mittens or a scarf for children in a homeless shelter. Or, you might want to contact social service organizations that work with families in need or foster children. Or,



you might want to make lap blankets or walker caddies for geriatric patients at the hospital or local nursing homes. As a participant in Care Wear Volunteers, YOU decide where to deliver/send finished items.

You can provide warmth & comfort to residents of your own community! You will make a difference in the lives of others. I believe that you will find this a very rewarding project!

Note: Care Wear Volunteers participants provide the supplies for their projects & deliver directly to hospitals, nursing homes, social service agencies, etc.



GENERAL INFORMATION

LABELS

You may attach a small label to each item you make and donate. This is not required. If you do attach this label, please attach with a safety pin or punch a hole in the paper label and attach with a piece of yarn. NO STRAIGHT PINS!



Made especially for you by:

Care Wear Volunteers
<http://www.carewear.org>



Made especially for you by:

Care Wear Volunteers
<http://www.carewear.org>



Made especially for you by:

Care Wear Volunteers
<http://www.carewear.org>



Made especially for you by:

Care Wear Volunteers
<http://www.carewear.org>



Made especially for you by:

Care Wear Volunteers
<http://www.carewear.org>



Made especially for you by:

Care Wear Volunteers
<http://www.carewear.org>

GENERAL INFORMATION

LABELS

This larger label is designed to be included in each delivery. You are welcome to design your own label to convey your name and contact information as well as contact information for Care Wear Volunteers.



Handmade
by Care Wear Volunteer

Name _____

Address _____

telephone: _____

E-Mail: _____

For more information about this program, contact:
Care Wear Volunteers
Bonnie Hagerman
102 Mercer Ct #23-5
Frederick, MD 21701-4070
Website: <http://www.carewear.org>
E-Mail: carewear@comcast.net
Telephone: 301-620-2858



Handmade
by Care Wear Volunteer

Name _____

Address _____

telephone: _____

E-Mail: _____

For more information about this program, contact:
Care Wear Volunteers
Bonnie Hagerman
102 Mercer Ct #23-5
Frederick, MD 21701-4070
Website: <http://www.carewear.org>
E-Mail: carewear@comcast.net
Telephone: 301-620-2858



Handmade
by Care Wear Volunteer

Name _____

Address _____

telephone: _____

E-Mail: _____

For more information about this program, contact:
Care Wear Volunteers
Bonnie Hagerman
102 Mercer Ct #23-5
Frederick, MD 21701-4070
Website: <http://www.carewear.org>
E-Mail: carewear@comcast.net
Telephone: 301-620-2858



Handmade
by Care Wear Volunteer

Name _____

Address _____

telephone: _____

E-Mail: _____

For more information about this program, contact:
Care Wear Volunteers
Bonnie Hagerman
102 Mercer Ct #23-5
Frederick, MD 21701-4070
Website: <http://www.carewear.org>
E-Mail: carewear@comcast.net
Telephone: 301-620-2858



Here is how Care Wear Volunteers got started. I read this article in December 1990, located my knitting needles, & the rest is history!!!!

A SEASON OF
LOVE,
A SEASON OF
JOY,
A
Reason
FOR
Sharing
...



*Here's the perfect opportunity to share a little bit of yourself
and your talents with babies in need of extra-special care.*

BY CAROLE SHELLEY YATES

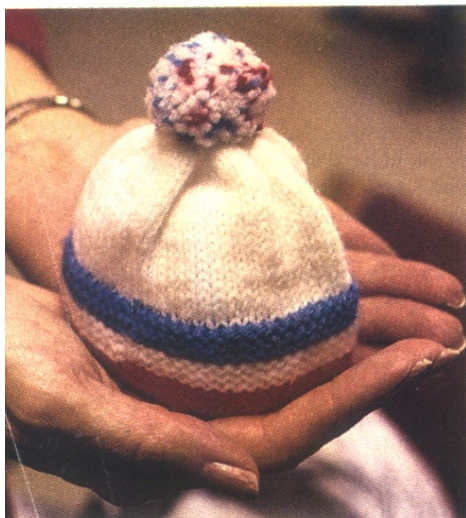

Crafters who knit, crochet, and sew have transformed a neonatal intensive care unit in Akron, Ohio, from a sterile atmosphere into a rainbow world of babies wearing tiny stocking caps and booties in colors that celebrate the holidays, seasons, and life itself. This volunteer project at Children's Hospital Medical Center started nine years ago and now provides much-needed garments each month for 100-150 premature babies, some of whom have major health problems.

If you're looking for a Christmas craft project, or perhaps one that

extends year-round, you can volunteer to knit or crochet tiny caps and booties, or sew small kimono-style gowns for premature infants in children's hospitals across the country. Children's hospitals welcome all of these garments, says Susan Bales, public relations person for the National Association of Children's Hospitals and Related Institutions. Even in a hospital's controlled environment, the tiny babies still need caps and booties for warmth. Their bodies, however, are too small for newborn-size clothes (some of the infants weigh less than 1 pound).

CHRISTMAS IDEAS 1990

At the Children's Hospital of Akron, nurses used cut-off tube socks to cover the infants' heads before volunteers started providing garments that fit, says Marilyn McGuckin, director of volunteers. "We now have a core of volunteers who regularly donate the most creative garments. Besides stocking caps, volunteers make tam hats, caps topped with big pom-poms, and others knitted in bright seasonal, holiday, and school colors."

Volunteers also are needed to make small mittens to keep some infants from pulling out stitches. In addition, doll-size kimono gowns can be sewn from soft, fire-retardant flannel materials for the babies.

"The babies in our neonatal intensive care unit start out so small, but after they progress through several stages, gain weight, and become healthier, then they go home wearing colorful caps and booties," McGuckin says.

"The caps-and-booties program is one of many examples of what volunteers in a community can do to support their children's hospital," remarks William H. Considine, president of Children's Hospital Medical Center of Akron. "It requires just a small investment of

time and money, but it means so much to the families of these infants. The caps and booties provide these families with a special keepsake of their baby's first days in this world. The program also provides a human touch of kindness at a critical time for parents and their newborn child."

Marie Parker, a new mother from Akron, supports Considine's comments. Her twin daughters were born last August and stayed in the Children's Hospital neonatal intensive care unit for three weeks.

"The caps and booties on the babies help take away some of the sterility of the high-risk unit; they help lighten up a serious situation," says Parker. "It's emotionally difficult to see your baby in an intensive care unit, hooked to a monitor and in an incubator. Parents are so worried about their children, but I noticed parents often giggled or smiled when they saw their baby wearing a perky cap."

For the Parkers, the caps brought an additional benefit. "They helped us tell our twins apart!" Marie Parker says. "Taylor wore a pink cap with a white fluffy ball on it and Brittany had a smaller pink hat."

If you want to glow inside this Christmas and all year-round, use



your crafting skills to help others by knitting, crocheting, or sewing infant garments for children's hospitals. Instructions and patterns for six projects are given on the next four pages.

For a local listing of hospitals that are members of the National Association of Children's Hospitals and Related Institutions, send in a self-addressed, stamped postcard to NACHRI, Attn.: Volunteer Coordinator—Baby Garments, 401 Wythe St., Alexandria, VA 22314. You'll not only help keep a precious baby warm, you'll also warm your own heart and busy hands.

Photographs courtesy of Rick Zaidan for Akron Children's Hospital



GENERAL INFORMATION (KNIT & CROCHET)

1. Yarn for baby hats should be washable (not wool). Wool may be used for blankets or slippers for older children and shawls for cancer patients, but should be clearly labeled.
2. Do NOT smoke or work on projects in a room where someone is smoking.
3. Keep these projects away from dogs, cats, or other pets.
4. You may use partial skeins leftover from your projects. Combine colors into stripes.
5. Seasonal colors, pastels, football team colors, bright colors, etc. may be used.
6. Wash hats that become soiled in construction. Do not use scented fabric softeners or sachet.
7. Package your completed items in plastic bags or tissue paper to protect from soil. More than one item may be placed in a plastic bag.
8. Make hats that are STRETCHY—especially at the bottom edge. These will fit various sizes & be comfortable on the infant.
9. Use very SOFT yarn for preemie and full-term hats as well as chemo hats.
10. Fabric paint is a suitable alternative to embroidery on toys & finger puppets.
11. Keep booties in pairs with yarn or a large safety pin. NO STRAIGHT PINS, please!!!
12. Booties stay on best if there's a ribbon or chained yarn tie around the ankle. Even if the pattern does not specify this, you can always add it. Secure ribbons or chains with a few hand stitches to prevent pulling out & swallowing.
13. Pompoms should be securely tied on—not glued on. Pompom makers are available in craft stores or made by wrapping yarn around a 1.5" x 2" piece of cardboard.
14. A satin ribbon bow on the top of a hat is easier & less bulky than pompoms. Thread 1/4" satin ribbon onto a tapestry needle. Weave in & out of the top of the hat. Tie a bow!

SIZES:

When knitting or crocheting, please keep in mind the approximate sizes for these infants. Head sizes for the infants in a Neonatal Intensive Care Unit vary from the size of a LIME or LEMON to larger than normal for full-term infants. Full-term, extra-large preemie, large preemie, and medium preemie sizes are the most requested sizes.

Here is a size chart (BODY MEASUREMENTS) for your reference.

Baby weight	Head circumference	Chest circumference	Foot length
1½ to 2lb	8½" to 9"	8½" to 9"	1"
2lb to 3lb	9½" to 10"	9" to 10"	1½" to 2"
3lb to 4lb	10½" to 11"	10" to 11"	2" to 2½"
5lb to 6lb	12" to 12½"	12" to 13"	2.5" to 3"
6lb to 7lb	13" to 13½"	13"	3" to 3½"
7lb to 8lb	14" to 15"	13½"	3½"
8lb to 10lb	16"	14"	3½"

Knitting/Crochet Pattern Abbreviations: <http://www.yarnspirations.com/abbreviations>
Needle/Hook Conversion Chart and Yarn Equivalents:

<http://www.bevscountrycottage.com/needlecharts.html>

KNIT PATTERNS

BASIC KNIT HAT

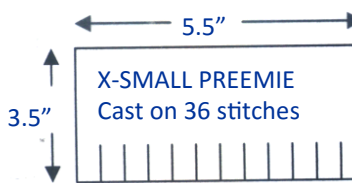
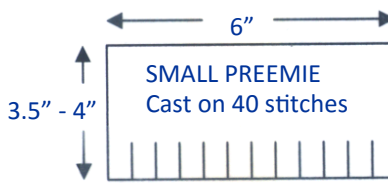
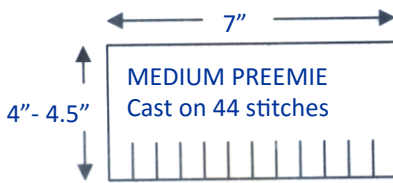
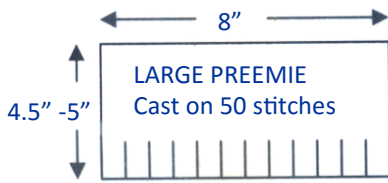
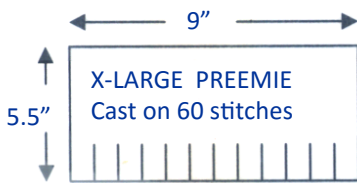
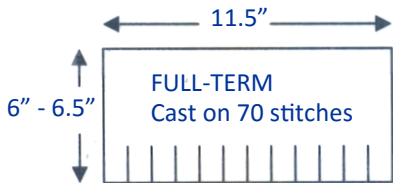

MATERIALS: soft, washable, 4-ply yarn. (Note: Four-ply yarn varies in thickness so adjust your work to achieve the finished sizes shown.)

NEEDLES: Size 6, 7, or 8 (to achieve the sizes shown)

DIRECTIONS: Cast on the number of stitches shown for the size.

-K2, P2 across each row to create 1"-2" of ribbing.

-At top of ribbing, change to stockinette & continue knitting until you reach the lengths indicated at left.

-Draw all stitches together tightly at the top by weaving yarn through all of the stitches on the needle. Knot securely.

-Weave seam edges together using matching yarn.

-Optional: Tie on a pompom or tie a ribbon bow on top.

NOTES:

1. Cast on LOOSELY so the bottom edge has good stretch.
2. You may knit the entire hat in a ribbing stitch.
3. You may wish to decrease (K2 tog) as you knit rows near the top of the hat (1" from the top) to reduce the bulk when pulling the top closed.
4. You may substitute smaller needles and/or 3-ply yarn. Simply knit to the dimensions shown.
5. If your 4-ply yarn is thick and stiff, don't use it for the very small sizes. Use a 3-ply yarn instead and cast on a larger number of stitches to achieve the same finished size.
6. Use double-pointed or circular needles to omit the seam.
7. Use leftover yarns in stripes. Arrange any way you wish. See illustrations below.
8. As you can see, premie head sizes vary from the size of a lime to full-term sizes. Within this range, gauge is not critical. If STRETCHY, your hat will be used.

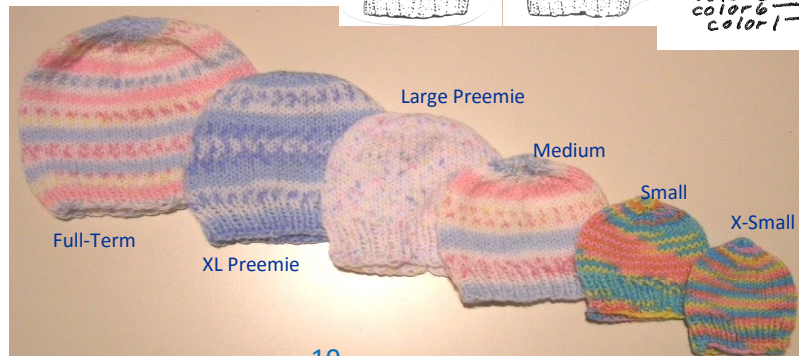

KNIT PATTERNS

THE PERFECT KNIT PREEMIE CAP

MATERIALS:

Soft baby or sport weight yarn, pastel colors or pastel ombres. Never use wool as some infants may be allergic.

NEEDLES: size 4 and 6

This is a rib pattern that will be visible after 3-4 rows.

SIZES:

Extra small: 29 st x 3 ½ inches long before decrease

Small: 33 st X 4 inches long before decrease

Medium: 37 st x 4 ½ inches long before decrease

Large: 41 st x 5 inches long before decrease



DIRECTIONS:

-Row 1: with size 6 needles, loosely cast on 29 (33, 37, 41) stitches.

-Row 2: K2, P2 across row, ending K1.

-Row 3: change to size 4 needles, K2, P2 across, ending K1.

-Continue in this manner until piece measures 3½ (4, 4½, 5) inches.

-First decrease row: K1, K2 tog across row. Purl one row.

-Next row: K3, K2 tog across. Purl one row.

-Next row: K2, K2 tog across. Purl one row.

-Cut yarn leaving about 12 inches and thread onto a yarn needle. Thread through remaining stitches and pull up tightly.

-Sew seam from bottom and knot off well with piece of yarn used to gather top.

-Cut ends to ¾ inch.

-Tie on a pompom, if desired.

Because these preemie hats keep their shape so well, they can be turned up and be used on tiny babies. They then stretch as the little head grows and the cuff can be adjusted.

This rib pattern can be used for any size hat, for children or adults, using larger needles and worsted weight yarn, increasing number of stitches and length of piece as needed. Always be sure to cast on a multiple of 4 stitches plus one and work all rows in K2, P2 until decrease rows, so the unique ribbing will appear. These hats, though very stretchy, hold their shape well.

Original pattern by Jane Bonning using measurements found in Care Wear publications. You may duplicate and share this pattern with anyone. *Jane Bonning*

"THE PERFECT KNIT PREEMIE CAP " MATCHING BOOTIES

MATERIALS: Soft sport weight or double knitting yarn. (I used Mary Maxim Baby Soft) a 50-gram ball will make 2 pair booties & 2 hats (1 large, 1 medium).

NEEDLES: Size 4 *

Continued on page 12

KNIT PATTERNS

"The Perfect Knit Premie Cap" Matching Booties pattern continued

PATTERN STITCH: Row 1: K2, P2 across, ending with K1.

Row 2: K2, P2 across, ending with K1.

Repeat these two rows.

DIRECTIONS:

- Cast on 25 stitches.
 - Work in pattern for 10 rows, decreasing one stitch on last row. (24 stitches).
 - Row 11: K10, inc; in next stitch, K2, inc. in next stitch. Knit to end (26 sts).
 - Row 12: Purl.
 - Row 13: K11, inc. in next stitch, K2, inc. in next stitch. Knit to end (28 sts).
 - Row 14: Purl.
 - Row 15: K12, inc. in next stitch, K2, inc. in next stitch. Knit to end (30 sts).
 - Row 16: Purl
 - Row 17: K13, inc. in next stitch, K2, inc. in next stitch. Knit to end (32 sts).
 - Row 18-23: Knit every row.
 - Row 24: K1, K2 tog., knit to last three stitches, K2 tog. K1 (30 stitches).
 - Row 25: Knit
 - Row 26: Repeat row 24 (28 stitches).
 - Row 27: Bind off all stitches OR K14 and then do a 3-needle bind off.
- Sew seam(s). Make a 16-18 inch cord or chain and insert between stitches at ankle.
- *To make booties that correspond to the sizes of the preemie cap, go down one size needle for medium, one more size for small and extra small.



THE FREDERICK MEMORIAL HOSPITAL FULL-TERM HAT PATTERN

NEEDLE SIZE: #6

MATERIALS: 100% acrylic 3-ply baby yarn

DIRECTIONS: Cast on 60 stitches

- Next row: K2, P2, to end of the row. Continue in this pattern for six inches.
- Next row: K2 tog, P2 tog across the row.
- Next row: Purl
- Next row: K2 tog across row
- Next row: Purl
- Next row: K2 tog across the row
- Thread yarn onto needle & take remaining stitches off needle.
- Draw tight.
- Sew cap seam and knot securely.
- Optional: Securely tie on a pompom or weave in a satin ribbon & tie a bow.



KNIT PATTERNS

THE PERFECT PREEMIE HAT--variation March 2005

(Seamless hat using double-pointed needles—by Shirley Brunner)

MATERIALS: Soft baby or sport weight yarn

NEEDLES: #4 Double Pointed

DIRECTIONS:

Cast on- X-small: 28 sts x 3½" long, before decrease
Divide 8-8-12 Makes 7 Ribs
Small: 32 sts x 4" long, before decrease
Divide 12-12-8 Makes 8 Ribs
Medium: 36 sts x 4½" long, before decrease
Divide 12-12-12 Makes 9 Ribs
Large: 40 sts x 5" long, before decrease
Divide 14-14-12 Makes 10 Ribs

(A multiple of 4 sts, will make hat larger)

PATTERN:

Row 1: K1, P2, ending with P2

Row 2: K1, P2, K2 repeat P2, K2 around, end K1.

Continue these 2 rows until desired length before decrease.

Decrease Rows

Row 1: K2 tog all around.

Row 2: Knit all around.

Row 3: K2 tog all around

Row 4: Knit all around

Then leave a long thread and draw remaining stitches together and tie off. A pompom or bow may be added. I make a "pig tail" by bringing yarn to the front and crochet about 10 chains, sc back (this causes it to curl). Pull yarn to the underside and fasten off. By fastening off this way the "pig tail" can be cut off if not desired.



Shirley wrote,

I modified this hat by eliminating the K2 & P2 band at the start. As the pattern is the same on each side (inside & outside), the hat can be folded to accommodate the baby's head as it enlarges. I use DP needles and I knit Continental style so switching from K to P often, with this pattern, is fast & easy.

When casting on, I do this on two needles BUT the first stitch is put on one needle, then I add the other needle & finish casting on. Then divide your stitches on 3 needles & join. BE CAREFUL you don't lose that first cast-on stitch as it gives a snug fit when joining. Then use the tail from casting on along with the yarn you are going to use to knit the hat. Do 2K (give both threads a tug), P2 and give the threads a tug, too. Then do the pattern with the yarn from the ball.

After doing the pattern for about 4 rows I take a bright color yarn to mark the beginning of my 1st needle. Go back to the 1st row & loop this yarn around the 1st stitch on the first needle. Follow the pattern.

KNIT PATTERNS

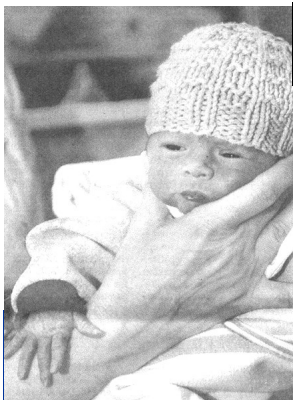

OSCAR'S CAP (3 SIZES)

This photo appeared in the *Frederick News-Post* when 5 sets of twins were born in a 36-hour period at Frederick Memorial Hospital. Oscar was one of the twins in the NICU. Many Care Wear participants noticed his cute hat & requested the pattern!!!



Small: (8"-9"). Medium: (10"-11"). Large: (11"-12") circumference.
Measurements are based on CAREWEAR patterns.

Materials: Bernat Softee Baby (2 skeins, one white, one pastel) (or use two strands of one color).

Hats were made with this yarn because it is soft - Red Heart Soft Worsted (1 thickness of yarn) should work.

Size 7 needles.

Gauge: 4-5 stitches = 1 inch (approximately)

Using 2 strands of yarn and #7 needles cast on 36 (44, 48) stitches VERY LOOSELY (or use a larger size needle) and work in K2, P2 ribbing for 1 inch. FOR THE MEDIUM SIZE ONLY DECREASE 2 STITCHES IN THE LAST ROW.

Work in pattern for 3-1/2" (4-1/2", 5-1/2"):

Pattern:

Row 1: Purl	Row 3: Purl
Row 2: Knit	Row 4: K2, P1 to end of row.

Shape crown: (right side facing)

Row 1: K4, K2 tog., repeat to end of row (30, 35, 40 sts.)
Row 2,4,6,8 Purl.
Row 3: K3, K2 tog., repeat to end of row (24, 28, 32 sts.)
Row 5: K2, K2 tog., repeat to end of row (18, 21, 24 sts.)
Row 7: K1, K2 tog., repeat to end of row (12, 14, 16 sts.)
Row 9: K2 tog around (#6, #7, 8 sts.)
Row 10: K2 tog. around (0, 0, #4 sts.)

Cut yarn, leaving long end. Weave through remaining stitches, draw up tightly and fasten off. Sew Seam/ Make a pom-pom for top of hat if desired.

ADJUSTMENT FOR WORKING ON FOUR DOUBLE POINTED NEEDLES: Knit rows 1, 2 and 3; Row 4: Purl 2 Knit 1 to end of round. In the crown shaping all rows will be knit stitch.

After seeing Oscar on the cover of the MARCH 2010 newsletter, Heather Rinkel created this pattern for the JUNE 2010 Care Wear Volunteers newsletter (p. 3). THANK YOU, HEATHER!

Revised 3/24/10

KNIT PATTERNS

A VARIATION OF "OSCAR'S CAP"

Sincere thanks to Jean Corazza who created this pattern for Care Wear Volunteers. It was first printed in the September 2010 newsletter.



Newborn: 12 inch circumference 6 $\frac{3}{4}$ inch height
#7 double points or 12 inch circular needle
Worsted weight yarn

Cast on 64 stitches, place marker for beginning of round & join.

Knit 2, Purl 2 for 1 inch

Pattern Stitch:

Row 1 Knit

Row 2 Purl

Row 3 Knit 2, Purl 2 across

Row 4 Knit 2, Purl 2 across

Repeat until hat measures 5 $\frac{1}{2}$ inches, ending on row 4

Decrease for top:

Row 1 Knit 4, Knit 2 tog across row ending with K4

Row 2 Knit

Row 3 Knit 3, Knit 2 tog across row ending with K4

Row 4 Knit

Row 5 Knit 2, Knit 2 tog across

Row 6 Knit

Row 7 Knit 1, Knit 2 tog across

Row 8 Knit

Row 9 Knit 2 tog across

Cut yarn leaving about 10 inches and weave through remaining stitches pulling tightly, fasten off.

Adult size makes a good chemo hat.

#8 16 inch circular needle

Cast on 80 stitches. Work ribbing of Knit 2, Purl 2 for 1 $\frac{1}{2}$ inches.

Follow pattern stitch above until hat measures 5 $\frac{1}{2}$ to 6 inches ending on row 4

Decrease in the same manner as newborn hat but start with decrease of Knit 6, Knit 2 tog

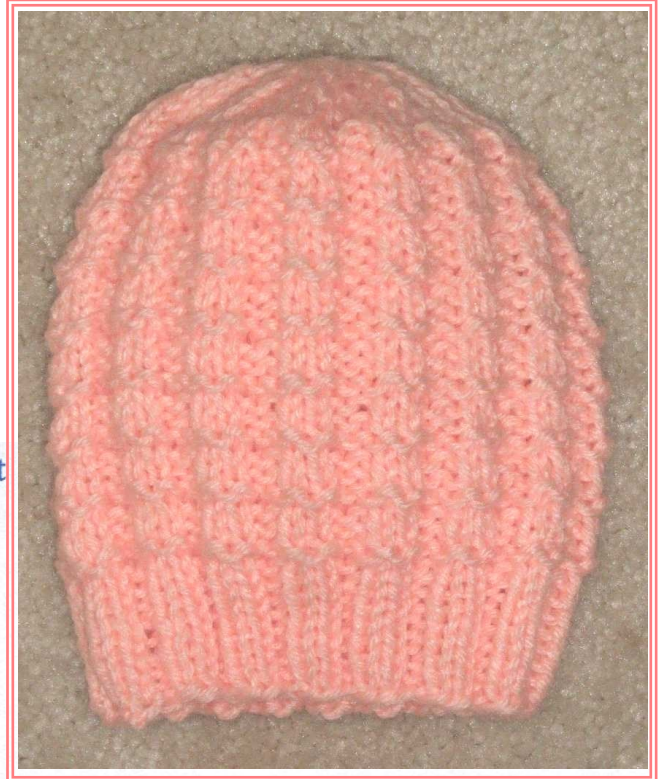

KNIT PATTERNS

BOOTIES TO MATCH OSCAR'S CAP

SIZES: to fit a 1 1/2" (2", 3") foot, approximately.

MATERIALS:

Bernat Softee Baby—1 skein of two different colors
Knitting Needles—Size #7

GAUGE: 4-5 stitches per inch, approximately.

Thank you to Heather Rinkel for creating his pattern that was first printed in the September 2010 newsletter.

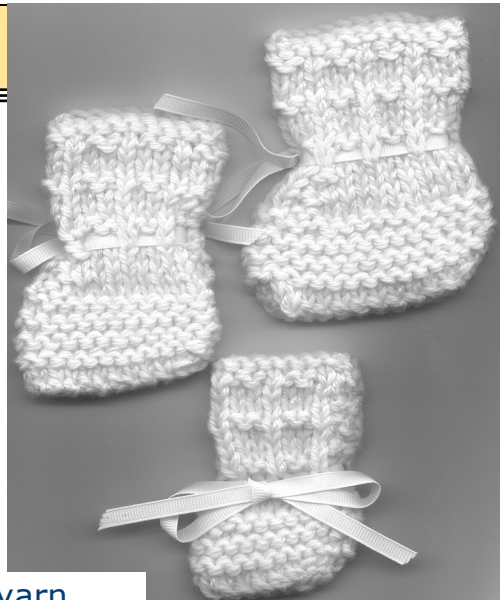

Cast on 18 (22, 26) stitches using 2 strands of yarn

Row 1: Knit, inc. stitch at each end of row (20,24, 28 sts.)

Row 2: Knit

Row 3: Repeat row 1 (22,26,30 sts.)

Knit next 3 (5) rows in garter stitch. (a total of 6 and 8 ridges (3 and 4 per side))

Shape foot:

Row 1: K8,(10,12) P2tog.,K2, P2tog.,K8 (10,12). (20,24,28 sts.)

Row 2: Purl

Row 3: K7,(9,11) P2tog.,K2, P2tog.,K7 (9,11). (18,22,26 sts.)

Row 4: 2"&3"sizes only: Purl

Row 5: 2"&3" only: K8,(10) P2tog.K2.P2tog.K8(10). (20,24sts.)

Begin pattern:

Row 1: Purl.

Row 2: P1., K.1 *P2.K.1, repeat from * to last 2 sts., P.1 .

Med. size only: *P.2,K.1, repeat from *to last 2 sts. P.2

Row 3: Purl.

Row 4: Knit

Repeat pattern once, then Rows 1 and 2 once. Bind off loosely (wrong side) knitwise (makes a nicer finish!). Sew seams.

Make a cord or use a ribbon to thread through the ankle of the bootie - if you use the knit stitch of the pattern as the "under" thread no holes are needed to thread the cord/ribbon through.

KNIT PATTERNS

Preemie Hat



Knit

■□□□
BEGINNER

SIZE

To fit preemie baby's head.

MATERIALS

Bernat® Softee Baby

(Solids 140 g/5 oz OR Ombres 120 g/4.42 oz)

1 ball

Size 4 mm (U.S. 6) knitting needles **or size needed to obtain gauge.**

GAUGE

22 sts and 30 rows = 4 ins [10 cm] in stocking st.

INSTRUCTIONS

Cast on 58 sts.

1st row: (RS). Knit.

2nd row: Purl.

Rep last 2 rows of stocking st for 8 ins [19 cm], ending with a purl row. Cast off.

Sew back seam, reversing bottom 1.5 ins [4 cm] for roll back.

Sew top seam. Fold 2 top corners tog and sew at center of top seam.

Roll bottom edge to desired depth of Hat.

Abbreviations: www.bernat.com/glossary

Preemie patterns were hard to find when Care Wear Volunteers started in 1991. Now, there are many sources. Reprinted with permission in the September 2011 Care Wear newsletter. www.bernat.com

TOYS

Do you have leftover yarn in "adult" colors? Consider making knit/ fiberfill toys. Look for patterns for toys in magazines and in booklets in your local craft store. The local Frederick hospital gives a toy to every child in the ER to calm & distract. *It works!!!!*



FAT CAT

An adorable toy is "FAT CAT" found in the JUNE 2011 newsletter (pages 14-15).

KNIT PONY PATTERN

Send me a s.a.s.e. for this PONY pattern or e-mail your request & I will attach the pattern to an e-mail reply.



KNIT PATTERNS

KNITTED BERET

MATERIALS: 3-ply baby yarn
#3 or #4 needles

DIRECTIONS:

- Cast on 8 stitches, purl back.
- Row 1: K1, yarn over (YO), K1, YO, all across row, always ending with K1.
- Row 2: Purl back.
- Row 3: K2, YO, K2, YO, all across row, ending with K1.
- Row 4: Purl back.

Continue increasing this way until desired size (Preemie beret measures 4.5" deep. Adult size is 8.5" diameter. That is about 10 YO increases for preemie & 25+ for adult.) THEN, knit rows for about one inch.

-Change to stockinette & decrease (K2 together) every 10th or 11th stitch on every knit row until there are 44 stitches on the needle for preemie size or 90 stitches on the needle for adult size.

-K1, P1 for about one inch or more.

-Bind off. Sew or crochet hat together. Tie on a pompom or bow.

Knit Beret

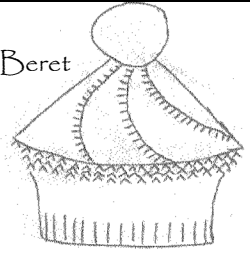

NOTE: You are knitting from the top of the beret downward—ending with the ribbing bottom.



COATS & CLARK RED HEART YARNS

This is a WONDERFUL free project sheet from Coats & Clark, Inc. There is a hat pattern for every head size and yarn weight. However, the preemie hat pattern at 12" circumference is an X-Large (almost full-term hat size). For the range of smaller preemie hats see the Care Wear patterns on page 10.

Here is a good pattern that you can use with variegated yarn, in patterns of stripes using leftover colors, as well as solid colors. Tie on a pompom or weave in a narrow satin ribbon for a bow on top.

PATTERNS ON PAGE 19

KNIT PATTERNS

RED HEART YARNS—GOTCHA COVERED #1

LW1268★

★ Suitable for Beginners

YARN QUALITY*	KNITTING NEEDLES	GAUGE in St st ON LARGER NEEDLES
A Fingering Weight	2.75mm [US 2] & 3.5mm [US 4]	26 sts = 4"; 35 rows = 4"
B Light Sport Weight	3.5mm [US 4] & 4mm [US 6]	22 sts = 4"; 30 rows = 4"
C Sport Weight	3.5mm [US 4] & 4mm [US 6]	20 sts = 4"; 27 rows = 4"
D Light Worsted Weight	4mm [US 6] & 5mm [US 8]	18 sts = 4"; 24 rows = 4"
E Worsted Weight	4mm [US 6] & 5mm [US 8]	17 sts = 4"; 23 rows = 4"
F Chunky Weight	5mm [US 8] & 6mm [US 10]	15 sts = 4"; 20 rows = 4"
G Bulky Weight	6.5mm [US 10.5] & 9mm [US 13]	9 sts = 4"; 13 rows = 4"

Amount: One skein each of 2 colors of any yarn quality will make one or more hats.

SIZE	1	2	3	4	5	6
TO FIT	Preemie	Baby	Toddler	Child	Women	Men
CIRCUMFERENCE	12"	14"	16"	18"	20"	22"

NOTE: Circle the numbers appropriate to the hat size and yarn quality you are making to help keep track of the pattern.

HAT-Cuff: With smaller needles and first color, cast on

A	77	93	105	-	-	-
B	65	77	89	97	109	121
C	61	69	81	89	101	109
D	53	61	73	81	89	97
E	49	57	69	77	85	93
F	-	53	61	69	77	81
G	-	33	37	41	45	49

sts. Work in ribbing as follows: **Row 1 (Right Side):** * K2, P2; rep from * to last st; K1. **Row 2:** P1, * K2, P2; rep from * across. Rep Rows 1 and 2 for

A-G	2½	3	4	5	6	6
------------	----	---	---	---	---	---

inches, end Row 1. **Crown:** Change to larger needles and second color and work in plain St st or stripes, beg K row, until

A-G	5	6	7	9	10	10
------------	---	---	---	---	----	----

inches from beg, end P row. **Shape Top:** [K2tog, K

A	15	19	22	-	-	-
B	12	15	18	20	23	26
C	11	13	16	18	21	23
D	9	11	14	16	18	20
E	8	10	13	15	17	19
F	-	9	11	13	15	16
G	-	4	5	6	7	8

sts, sl 1, K1, pssso, place marker on needle] 4 times, K1. **Next Row:** [K2tog, K to 2 sts before marker, sl 1, K1, pssso] 4 times, K1. Rep the last 2 rows until the row "[K2tog, K1 OR K2, sl 1, K1, pssso] 4 times, K1" has been worked and 13 OR 17 sts rem. Cut yarn, leaving a long end; weave through rem sts, draw up tightly and fasten securely. Sew seam, reversing for cuff turnback. Fold cuff in half to the right side. **Optional:** Make a pom pom and fasten to top of hat.

***Yarn Quality:** **A** = RED HEART® Baby Fingering Traditional and Pompadour. **B** = RED HEART® Soft Baby. **C** = RED HEART® Sport; Baby Sport Econo. **D** = RED HEART® Soft; Kids; Baby Teri; Tweed. **E** = RED HEART® Super Saver; Classic; Fiesta; Pounder; Classic Plus. **F** = RED HEART® Misty. **G** = RED HEART® Light & Lofty; Baby Clouds.

ABBREVIATIONS: **beg** = beginning; **K** = knit; **P** = purl; **pssso** = pass the slipped stitch over; **rem** = remain(ing); **rep** = repeat; **sl** = slip; **st** = stitch; **St st** = Stockinette stitch (K1 row; P1 row); **tog** = together; * = repeat whatever follows the * as indicated; [] = work directions given in brackets the number of times specified.



KNIT PATTERNS

LION BRAND® BABYSOFT SO-SOFT PREEMIE HAT



Pattern Number: NW09221006K

SKILL LEVEL: Easy

SIZE: Small Preemie
Medium Preemie
Large Preemie

CIRCUMFERENCE:
6 (7, 8) inches measured flat
(half of total circumference).



www.lionbrand.com

FINISHED LENGTH: 3¾ (5, 5½) inches

MATERIALS:

- 920-100 Lion Brand Babysoft: White (1 Skein Makes 8-9 hats)
- Double-Pointed Needles -- Size 5
- Stitch Markers
- Large-Eye Blunt Needle

GAUGE:

6 stitches to an inch over Pattern Stitch.
BE SURE TO CHECK YOUR GAUGE.

STITCH EXPLANATION: **Rnds 1 and 2:** Knit.
Rnd 3: P1, K2.
Repeat Rnds 1-3 for Pattern Stitch.

HAT

—Cast on 36 (42, 48) sts. Divide sts evenly onto 3 needles. Join, being careful not to twist sts. Place marker for beg of rnd.

—Work in K1, P1 rib for 1 (1.5, 1.5) inch, then work in Pattern Stitch until piece measures 3 (3.5, 4.5) inches from beg.

SHAPE CROWN:

Next Rnd: *K4 (5) (6), K2 tog, repeat from * around - 30 (36, 42) sts.

Rnd 2: *K3 (4) (5), K2 tog, repeat from * around - 24 (30, 36) sts.

Rnd 3: *K2 (3) (5), K2 tog, repeat from * around - 18 (24, 30) sts.

Continue to decrease in this manner until there are 6 sts left.

Next Rnd: (K2 tog) around - 3 sts.

CORD (for top knot): *Slide remaining 3 sts to other end of needle and knit them, pulling yarn tightly across the back of the work. (Do not turn work.) Repeat from * to make cord, working until cord measures 1.5 (1.75, 1.75) inches. Bind off.

FINISHING: Weave in ends. Knot cord.
Turn up ribbed cuff.

Lion Brand Yarn has several preemie patterns available in its collection of FREE KNIT patterns. Previously reprinted with permission in the June 2010 Care Wear newsletter.

KNIT PATTERNS

SEAMLESS PREEMIE & NEWBORN PUMPKIN HAT

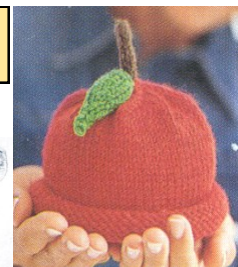

Apple
variation!

Materials: 4 ply worsted weight yarn orange and small amount of bright green for stem.*
double pointed needles #6 and #8

DIRECTIONS: small preemie given, medium and large preemies and newborn in (). With orange and LARGER needles, starting with a single loop, which counts as a knit st, double cast on 36 (42- 48-54) sts in (K1, P1) rib pattern on 3 needles. Being careful not to twist sts, join by knitting the single loop at the beginning with the tail end of the yarn. This eliminates a bump at the joining. Change to SMALLER needles and work rib pattern for 1 ½" (2"- 2 ½"-3").** Change to LARGER needles and work hat pattern:

Rnd 1: [K5 (6-7-8), P1] around. Repeat this rnd until total length is 3" (4"-5"-6") from beginning.**

DECREASE as follows:

Rnd 1: [(Slip the next st onto the tip of the right hand needle knit-wise and return it to the left hand needle, reversing the direction of the st on the left hand needle, then K2 tog in back loop = SR2B), K to last 2 sts before P st, K2 tog, P1] around - 24 (30-36-42) sts.

Rnds 2 and 4: (K all K, P all P) around.

For small preemie only:

Rnd 3: (K2 tog, P2 tog) around - 12 sts.

Rnd 5: K2 tog around - 6 sts. Leaving a 6" tail, cut orange. Work stem.

For medium preemie only:

Rnds 3 and 4: Repeat rnds 1 and 2 - 18 sts.

Rnd 5: (K2 tog, P1) around - 12 sts.

Rnd 6: as rnd 2. Leaving a 6" tail, cut orange. Work stem.

For large preemie only:

Rnds 3 and 4: Repeat rnds 1 and 2 - 24 sts.

Rnd 5: (K2 tog, P2 tog) around - 12 sts.

Rnd 6: as rnd 2. Leaving a 6" tail, cut orange. Work stem.

For newborn only:

Rnds 3-6: Repeat rnds 1 and 2 twice - 18sts.

Rnd 7: (K2 tog, P1) around- 12 sts.

Rnd 8: as rnd 2. Leaving a 6" tail, cut orange. Work stem..



STEM: With green and SMALLER needles, knitting all sts onto one needle as you go along, K2 tog around 3 (6-6-6) sts.

Next row: Slide sts to other end of needle. Bring the yarn around the back of the sts to the first st and knit all sts. Repeat for 5 (6-7-9) rows** or desired length for stem. Next row: K2 tog 0(3-3-3) times. [Congratulations! You have just made an "I(diot) Cord". Very useful for bonnet and cap ties, purse handles, connecting mittens through coat sleeves, etc.] Leaving a 6" tail, cut green, thread on yarn needle and pull through remaining sts, gathering them tightly.

FINISHING: Work needle through stem from top to bottom and pull on it gently, making the stem curve. Secure end firmly. Snug up orange and green ends tog where they meet on inside of hat to close any gap between the colors and knot them together. Weave in ends.

Weave cuff end on the inside of the turn up.

Be on the look out for the Great Pumpkin and report any Charlie Brown sightings in nurseries.

*If anybody finds a source for reasonably priced sport weight yarns we can use (not wool), I could work up patterns for needle sizes #3 and #5 and #4 and #6.

**None of these measurements are carved in stone. Whatever looks "right" is OK.

Copyright 2003 by Cathy Gilroy. Permission given for Care Wear use only.

KNIT PATTERNS

SEAMLESS JESTER-TYPE HAT

Note: Knit a hat in each yarn and each set of needle sizes to see different gauges.

Materials: 3 ply sport weight yarn
double pointed needles in sizes:
#3 & #5; #4 & #6; #5 & #7.
and/or
4 ply worsted weight yarn
double pointed needles in sizes
#4 & #6; #5 & #7; #6 & #8; #7 & #9;
#8 & #10; #9 & #10 ½ ; #9 & #11

DIRECTIONS: With LARGER needles, starting with a single loop, which counts as a knit st, double cast on 60 sts on three needles (20-20-20) in (K1, P1) rib pattern. Being careful not to twist sts, join by knitting the single loop with the tail end of the yarn. Return this st to the left hand needle. Tug on tail to snug up the join. This eliminates a bump at the joining. Change to SMALLER needles and work in rib pattern as established for 20 rounds. Change to LARGER needles and work in stockinet st (knit all rounds) for 20 rnds. Then, K30, and put on one needle. See * and directions for finishing.

JESTER TYPE HAT WITH SEAM "B"

Note: Knit a hat in each yarn and each set of needle sizes to show different gauges.

Materials: yarns same as above
straight needle sizes same as above

DIRECTIONS: With LARGER needle, double cast on 61 sts in (K1, P1) pattern, end K1. Change to SMALLER needle. Work in rib pattern as established: K all K and P all P as they appear for 20 rows. Change to LARGER needles and work stockinet st:
Row 1 (right side = rs): Knit
Row 2 (wrong side): Purl
for 20 rows. Then, on rs, K31. Fold hat, wrong sides tog. See * and directions for finishing.

*Please note: Until this hat is put on a precious little head it's just a bland rectangle.

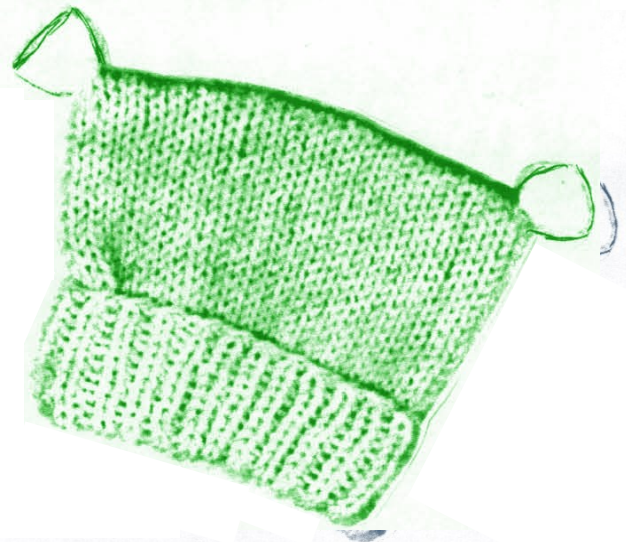

FINISHING: For "A": With yarn end you're knitting with, measure back and forth across 30 sts on needle four times; add about 6" and cut yarn. For "B": Do as above but also add enough yarn needed to sew side seam. Weave top tog. Weave cuff yarn end on inside of turn up. NOW! Securely attach a pompom, bell, star, etc. to the "ears" or "horns" in a spiffy color. You just made a hat and a swatch for each yarn/needle combination. You're so smart!

If weaving is new to you, practice this way: Cast on 20 sts. Work st st for 6 rows. Next row: With contrasting color yarn, K across. Cut contrasting color, leaving about a 2" tail. With another contrasting color yarn, right side facing, work st st for 6 rows. Bind off loosely. You now have two pieces joined by a separate length of yarn. Look carefully at the way the yarn goes in and out for the joining. This is how you will weave the hat top together. Thread a blunt tapestry needle with a length of yarn four times the width of the swatch plus 6". Go to the start of the first contrasting yarn knit row. Slowly pull out the yarn that made the first st and as you do, follow it exactly with the threaded needle, snugging up each st as you go along. Do that across the row, checking that the sts you've made look just like the sts that haven't been pulled out of the other end of the row. You should be ready to weave the hat top tog now. If unsure, you can see instructions in "how to knit" books or on line at www.knitting-crochet.com.

KNIT PATTERNS

SEAMLESS PREEMIE & NEWBORN ARAN STYLE HAT #14

Materials: 3 ply sport weight yarn, (a pattern for an experienced knitter)
 double pointed needles #4 and #6
 OR 4 ply worsted weight yarn,
 d p needles #6 and #8

DIRECTIONS: preemie given, other in ().
 With **larger** needles, starting with a single loop, which counts as a knit st double cast on 44(66) sts in (K1, P1) pattern. Being careful not to twist, join by knitting the single loop with the tail end of the yarn. Return K st to left hand needle (LHN). Tug on end to tighten st. Change to **smaller** needles and work in Twist Rib pattern for 11(22) rnds. Change to **larger** needles and work in hat pattern – multiple of 22 sts.

Rnd 1: (K4 – P2 – K3 – P2) around.

Rnd 2: (K4 – P2 – K1 in bl, P1, K1 in bl – P2) around.

Rnd 3: (2B – P2 – K3 – P2 – 2F – P2 – K3 – P2) around.

Rnd 4: as rnd 2.

Repeat these 4 rnds for pattern. End after 11(23) rnds [3(6) cables] have been completed.

Decrease as follows:

Rnd 1: [(K2 tog) twice – P2 tog – K2 tog in bl, K1 in bl – P2 tog – SR2B twice – P2 tog – K2 tog in bl, K1 – P2 tog] around – 24 (36) sts.

Rnd 2: (K2 – P1) around.

Rnd 3: Slip first st as if to P, (SR2B – K2 tog in bl – K2 tog) around to last st. K last st and slipped st tog – 12(18) sts.

Rnd 4: K around.

Rnd 5: K2 tog around – 6(9) sts

Rnd 6: Lay yarn over LHN in front of first st and pull sts over it one by one. All sts are off needles and one st remains.

Allowing for a 6" tail, cut yarn and pull through this last loop.

FINISHING: Thread yarn needle, drop through hole, turn hat inside out, pull up yarn tightly to close hole and weave yarn end through last sts twice, then through several sts outside circle. Weave in cuff yarn end on inside of turn up.



TWIST RIB PATTERN;

Rnd 1: [K1, P1 in back loop (bl)] around.

Rnd 2: (K1 in bl, P1) around.

Repeat these two rounds for pattern.

2x2 BACK CABLE PATTERN = 2B:

No extra “cable needle” needed!

Drop 4 sts from LHN. (They will NOT run away.) With LHN in back, pick up first 2 sts. With right hand needle (RHN) in front, pick up last 2 sts and slip them onto LHN. Sts are now in proper order to knit a front cable cross.



2x2 FRONT CABLE PATTERN = 2F:

Drop 2 sts from LHN. (They won't run away, either.) With RHN in back of these 2 sts, slip the next 2 sts onto RHN. With LHN in front, pick up first 2 sts. Slip sts from RHN onto LHN. Sts are now in proper order to knit a front cable cross.

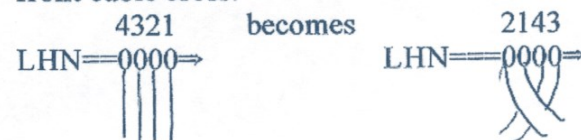

Copyright 2003 by Cathy Gilroy.

Permission given for Care Wear use only.

See the MARCH 2003 newsletter (p. 10-17) on the Care Wear Volunteers website (<http://www.carewear.org>) for 8 variations of Aran-style hats by Cathy Gilroy.

KNIT PATTERNS

SEAMLESS SANTA HAT



Materials: Red Heart Baby Sport Pompadour – red

OR 3 ply sport yarn - red
 3 ply sport yarn – white and
 double pointed needles #5 and #9.
 crochet hook size G

Note: Use size 7
 needle if yarn is fine.

NOTE: Red yarn is stiffer and works up heavier than white, so larger size needles are needed.

DIRECTIONS: Premie given, newborns in (). With white and LARGER needles, starting with a single loop, which counts as a knit st, double cast on 54 (60-68) sts in K1, P1 rib pattern on 3 needles. Being careful not to twist sts, join by knitting the single loop with the loose yarn end. Return knit st to left hand needle (LHN). Tug on end to tighten st. This eliminates a bump at the joining. Change to SMALLER needles. Work in (K1, P1) rib for 2” (2 ½”- 3”). Break off white. Change to LARGER needles. With red, knit even around until total length is 4”(5”-6”). K 27 (30 - 34), place marker, K to end.

DECREASE as follows:

Rnd 1: *K2 tog - K to 3 sts before marker, (slip the next st knit-wise onto right hand needle and return it to left hand needle, reversing direction of st) – K2 tog through back loop, K1* – slip marker then repeat between * * once.

Rnds 2 and 3: K even around.

Repeat these 3 rnds until 6 sts remain in dec. rnd. Lay yarn over needle in front of first st and pull sts over it one by one. Allowing

yarn for finishing, cut red and pull through last loop. Thread yarn in tapestry needle and drop through hole. Turn hat inside out, pull up yarn tightly to close hole and weave yarn through last rnd twice, then through a few sts outside circle.

BELL: With crochet hook and white, leaving a 4” tail, wrap yarn around finger twice, making a ring. Sl st into ring, ch 2 (3) – 6 half dc (dc) into ring - sl st into top of ch 2(3) – ch 2(3). Cut yarn, leaving a tail for finishing. Pull yarn through hole and pull up tightly on starting yarn to close hole, forming a bell shape. Thread both yarn ends together in tapestry needle and weave them through last rnd of hat, (cleverly, so white doesn’t show) twice, attaching bell securely. Poke needle through center, turn hat inside out and weave in ends. Did I say it would be easy? It’s cute, though, isn’t it? For larger bells, tr cr or 2 rnds of half dc or dc and more sts in ring. A pom-pom can be used instead of a bell.

AFTER you have made two hats for Care Wear, make a set for your family, then use remaining yarn for more Care Wears.

DIRECTIONS for toddler (child - woman - man), using 4 ply worsted weight yarn, dp needles #6 & #10: With LARGER needles, double cast on 60 (68 – 76 – 80) in (KI, P1) pattern. Change to SMALLER needles and work in rib pattern for 4”(5” – 6” – 6”). Change to LARGER needles and work in plain knit until total length is 8” (10” – 12” - 12”). Next rnd: K 30 (34 – 38 – 40), place marker and work decrease as above.

FOR SPORT WT and #5 & #9 dp needles: dbl cast on 80 (88 – 100 – 108) and work as above. For decrease: K 40 (44 – 50 -54), place marker and work decrease as above.

ABBREVIATIONS: ch = chain

dec = decrease

rnd = round

dc = double crochet

K = knit

sl st= slip stitch

tr cr = triple crochet

P = purl

st(s) = stitch(es)

Copyright 2002 by Cathy Gilroy. Permission given for Care Wear Volunteers use only, as noted above.

KNIT PATTERNS

CHILD'S CHEMO HAT WITH BRAIDS

Materials: 1 skein knitting worsted yarn (Lion Brand Wool-Ease) (will make more than one hat)
1 skein worsted yarn to make braids, color black, red, brown, or blond.
Double point knitting needles, size 5 and 6.
Hat can also be made using two needles.

Gauge: 5 stitches to 1" on #6 needles

With smaller needles, cast on 80 (90) stitches. Join, being careful not to twist stitches. Work 6 rows in garter stitch.

Change to larger needles and work 5-1/2" (6") in stocking stitch (or pattern of choice). If using two needles end with a purl row.

Next row: *K6 (K7), K2tog* repeat from between * to end of row.

2nd Row: Knit (Purl if using two needles)

(& all even rows)

3rd row: *K5 (K6) K2tog* repeat between * to end of row.

5th row: *K4 (K5) K2tog* repeat between * to end of row.

Continue in this manner, having one stitch less in each repeat, until 10 (20) stitches remain.

Next row: k2tog. across row.

Cut yarn, pull yarn through remaining stitches and fasten off. Make pompom if desired. For a variation instead of a pompom: continue to K2tog. each row until you have 4 stitches left and then knit an I-cord for about 8 rows, fasten off, tie it into a knot or make a top-knot.

If using two needles sew up back seam.

TO MAKE BRAID: Make 2

Cut 15 strands of yarn per braid approximately 18 to 20 inches in length. Tie with separate strand of yarn in middle, fold in half. Divide the resulting 30 strands of yarn into 3 groups of 10 and braid. Using the yarn which you tied in the middle, attach braid on each side of hat. Rather than cut the thread, pull it through the braid (that way the braid can be removed and re-attached if it's not in the right place!). I then attach a bow or a rose to hide where the braid was attached.

No longer requested by Johns Hopkins Child Life Center for young chemotherapy patients, but a cute idea! Check with your local cancer center.

A photo of a young patient at Johns Hopkins.



25



KNIT PATTERNS

BABY BLANKET

(also known as the "washcloth" pattern)

MATERIALS:

2 (8 ounce) skeins 4-ply yarn or two strands of baby or sport weight yarn.

NEEDLES: Size #10-13

DIRECTIONS:

- Cast on 4 stitches.
- Row 1: K2, yarn over (yo), knit to end of the row.
- Row 2: K2, yo, knit to end of the row.
- Continue these two rows of garter stitch (knit every row) until one edge of the triangle measures the length you desire (between 32"- 36") OR you have used one skein of yarn. When you have reached this halfway mark, continue as follows.
- Row 1: K1, K2 tog, yo, K2 tog, knit to the end of the row.
- Row 2: K1, K2 tog, yo, K2 tog, knit to the end of the row.
- Continue these 2 rows until 4 stitches remain. Bind off.

(When there are too many stitches to continue working on straight needles, switch to a circular needle. A 29" circular needle works well.)

This blanket looks lovely when a satin ribbon is threaded through the eyelet holes and tied in a bow in one corner.

DIRECTIONS: Cast on 21 stitches

- Knit each row for about 1 inch.
- K1 *yo, K2 tog, repeat from * to end of row.
- Knit 1 row.
- Knit 7 stitches, place on holder, increase 1 in next stitch, knit next five stitches, increase 1 in next stitch, place last 7 stitches on holder.
- Knit each row for 1 1/4" (center 9 stitches only). Cut yarn leaving 4-5 inch strand.
- Attach yarn & knit stitches from second holder, pick up & knit stitches from 1st side of center piece, knit 9 center stitches, pick up & knit stitches from 2nd side of center piece, knit stitches from first holder.
- Knit each row for 6 more rows.
- Knit up to 7 center stitches, K2 tog, K3, K2 tog.
- Knit a row
- Knit up to 5 center stitches, K2 tog, K1, K2 tog.
- Knit a row.
- Knit up to 3 center stitches, K3 tog.
- Knit last row, casting off as you do.
- Finish by sewing up bottom & back seams and weaving in leftover yarn.
- Thread ribbon through row with yarn overs.

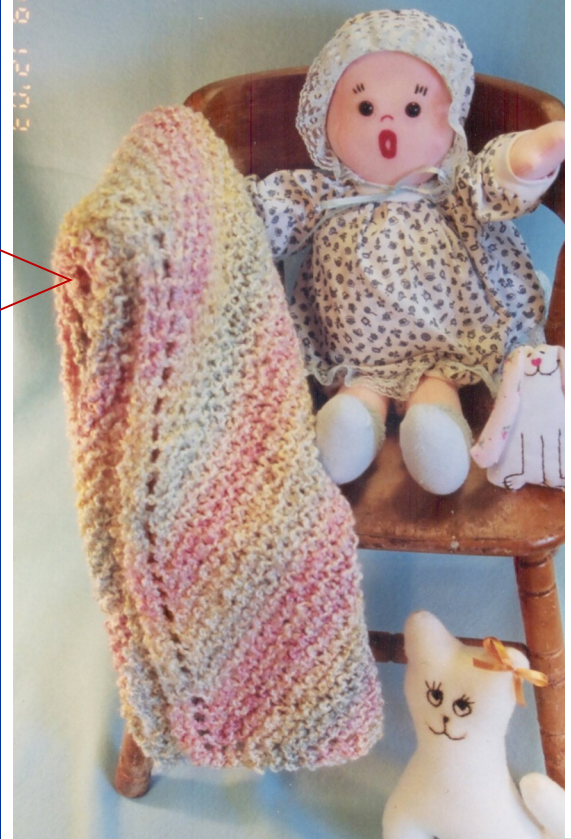

BABY BOOTIES

Using baby yarn & fine needles (size 1), you will produce a PREMIE SIZE. Increase to 24 stitches for a larger size.



It is recommended that you use double-pointed needles and work on the two booties at the same time to ensure two finished booties of the same size!

KNIT PATTERNS

KNIT SNUGLER (a positioning tool for NICU infants)

Designed by Sharri Shively. Permission to use for all Care Wear affiliates.

Yarn: 4-ply worsted or 3-ply baby sport or sport yarn

Needle and Stitches: Whatever gauge you determine that will give you a finished product of 5½” to 6” wide and 26” to 30” long.

Gauge: Use suggested gauge for making Care Wear 5½” to 6” hats. (Page 10 Small or XS Preemie Hat)

Finished product should not be knitted too loosely, as it will stretch too much when being stuffed.

Suggested Stitches: Stockinette, garter, moss.

Patterns: Variegated yarn, stripes, ripple (just avoid loose, open stitches).

Colors: Keep it pastel, but have fun mixing leftover yarns.

Note: Knot colors when joining and leave at least a 2” tail; these tails can be worked to inside when stuffing.

SEWING AND STUFFING THE SNUGLERS

Version 1: Stuff as you finish

- When ending piece, do not cast off! Cut yarn at 45”, place on sewing needle, and run yarn length through the stitches on the knitting needle.
- Remove from knitting needle; draw up stitches and lock stitch.
- Use the remaining length of the yarn to sew up the snuggler.
- Sew using a weaving stitch, one per row of knitting. Keep it loose to prevent a ridge, but don't get sloppy loose either.
- Stuff as you sew, filling at least 1/3 to 1/2 of the snuggler length at a time. The longer the piece of fiberfill, the less it will bunch when washed. Also, overlap the fiberfill ends at least 2”, using a thinner thickness at the overlap edges, so there is no bump.
- The finished project should feel like a very soft loaf of bread when squeezed. It will bend over when held vertically, but not flop in half. One 20 oz bag of fiberfill will stuff 8 to 10 snugglers, depending on how loosely or tightly they are knitted.
- To end, lock stitch at end of sewn seam (if you don't lock stitch now, when you pull together it will pucker your seam). Run a gathering stitch around open end, pull tightly and lock stitch at least twice. Hide leftover length of yarn into body of snuggler by jabbing through and pulling out other side several inches away, then trim off whatever is sticking out.

Version 2: Knit Now, Stuff Later

- Bind off, stow in purse, pocket or other until you are ready to stuff. Leave 45” yarn end for sewing later.
- To sew and stuff: Starting with bound off edge, run a gathering stitch, pull tight and lock stitch.
- Use the remaining length of yarn to sew as described in **Version 1**, ending the same way.



KNIT PATTERNS

BURIAL GOWN & BONNET



Chest	Small	Preemie	Newborn
Size	12"	14"	16"

MATERIALS

- Baby or lightweight Sport weight yarn approximately 4 ozs
- Size 7 knitting needles **or** size needed to obtain gauge for each size
- Yarn needle for sewing seams and ends
- Ribbon for ties at back neck
- Ribbon roses, bows, or buttons to embellish front if desired

GAUGE

In Garter Stitch (knitting each row):

Size Small ONLY: 22 sts = 4"

Size Large ONLY: 20 sts = 4"

Size Full Term ONLY: 18 sts = 4"

SKIRT

Cast on 132 sts **loosely**.

Row 1: Knit across.

Row 2 (Right side): K1, * slip 1 as if to knit, K1, pssso, K9, K2tog; repeat from * across to last st, K1: 112 sts.

Row 3: Purl across.

Row 4: K1, * slip 1 as if to knit, K1, pssso, K7, K2tog; repeat from * across to last st, K1: 92 sts.

Row 5: Purl across.

Row 6: K1, * slip 1 as if to knit, K1, pssso, YO, (K1, YO) 5 times, K2tog; repeat from * across to last st, K1: 132 sts.

Repeat Rows 1-6 for pattern until dress measures approximately 11(12-13)" from beginning or until desired length, ending by working pattern Row 5.

Bodice-Row 1: K2 tog 12 times, cast on 15 sts **loosely** (for Armhole), K2tog 22 times, cast on 15 sts **loosely** (for Armhole), K2tog 12 times: 76 sts.

Row 2: Knit across.

Row 3: K10, K2tog, K15, slip 1 as if to knit, K1, pssso, K18, K2tog, K15, slip 1 as if to knit, K1, pssso, K10: 72 sts.

Rows 4-6: Knit across.

Row 7: K9, K2tog, K15, slip 1 as if to knit, K1, pssso, K16, K2tog, K15, slip 1 as if to knit, K1, pssso, K9: 68 sts.

Rows 8-10: Knit across.

Row 11: K8, K2tog, K15, slip 1 as if to knit, K1, pssso, K14, K2tog, K15, slip 1 as if to knit, K1, pssso, K8: 64 sts.

Rows 12-14: Knit across.

Row 15: K7, K2tog, K15, slip 1 as if to knit, K1, pssso, K12, K2tog, K15, slip 1 as if to knit, K1, pssso, K7: 60 sts.

Rows 16-18: Knit across.

Row 19: (K3, K2tog) across: 48 sts.

Row 20: Knit across.

Row 21: (K6, K2tog) across: 42 sts.

Row 22: Knit across.

Bind off all sts **loosely**.

SLEEVE (Make 2)

Cast on 28 sts **loosely**.

Repeat Rows 1-6 of Skirt, 5 times or until Sleeve is desired length, then work pattern Row 1 once **more**.

Bind off all sts **loosely**.

KNIT PATTERNS

Burial Gown & Bonnet pattern continued from p. 28

Finishing: Sew sleeve seam and then sew bound off edge to armhole. Repeat for second sleeve. Leave center-back seam open for ease of dressing and add ribbon ties or Velcro tabs to the back neck for closure. Add decorative touches to the front as desired.

BONNET

Cast on 54 sts **loosely**.

Row 1: Knit across.

Row 2 (Right side): K1, * slip 1 as if to knit, K1, pssso, K9, K2tog; repeat from * across to last st, K1: 46 sts.

Row 3: Purl across.

Row 4: K1, * slip 1 as if to knit, K1, pssso, K7, K2tog; repeat from * across to last st, K1: 38 sts.

Row 5: Purl across.

Row 6: K1, * slip 1 as if to knit, K1, pssso, YO, (K1, YO) 5 times, K2tog; repeat from * across to last st, K1: 54 sts.

Repeat Rows 1-6, 4 times, then repeat Row 1 **once** more.

Back

Row 1: K21, K2 tog 6 times, K21: 48 sts.

Row 2 and all wrong side rows: Knit across.

Row 3: K18, K2 tog 6 times, K18: 42 sts.

Row 5: K15, K2 tog 6 times, K15: 36 sts.

Row 7: K12, K2 tog 6 times, K12: 30 sts.

Row 9: K9, K2 tog 6 times, K9: 24 sts.

Row 11: K6, K2 tog 6 times, K6: 18 sts

.Bind off all sts **loosely**. Sew back seam. Add ribbon ties. Weave in all yarn ends.

Designed by Terry Kimbrough ©2012

EASY BOOTIES FOR PREEMIES

MATERIALS: Baby Yarn Size #5 needles

DIRECTIONS:

- Cast on 30 (26, 22, 20) stitches, leaving about 8" or 9" of yarn to sew back seam.
- Knit in garter stitch 18 (14, 12, 10) rows —9 (7, 6, 5) ridges.
- Bind off at beginning of next two rows 7 (6, 5, 4) stitches.
- Knit 14 (12, 10, 8) rows—7 (6,5,4) ridges.
- Decrease one stitch at each end of next row.
- Knit one row plain.
- K2 tog across next row.
- Cut yarn, leaving about 10" to 12".
- With needle, thread yarn through remaining stitches & gather into circle for toe.
- Sew edges together for top of foot.
- Front of leg can be sewn together but left open would be easier to put on baby.
- With end of casting-on yarn, sew up back seam gathering up last 5 or 6 sts to round the heel.

SIZES: Large= 2 3/4"
Medium= 2 1/4"
Small= 2"
X-Small=1 3/4"



FINGER PUPPETS

MATERIALS:

Size #1 or #2 needles
Odd bits of baby yarn or fingering yarn
Embroidery floss or textile paint

DIRECTIONS:

- Cast on 24 stitches using #1 or #2 needles.
- Do 6 rows, beginning each row with purl (P, K, P, K, etc.).
- Change color.
- Do 8 rows beginning each row with K, K, then continue P, K, P, K, etc. to end of row.
- Change back to first color.
- Do 6 rows, beginning each row with purl (P, K, P, K, etc.) to end of row.
- Run single strand of yarn through top of puppet to gather.
- Pull tightly & knot.
- Sew seam down the back of the puppet.
- Add pom-pom or bow on top.
- Embroider or paint eyes, nose, & mouth.

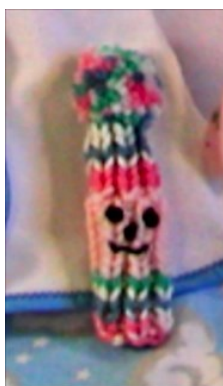

Like the Alzheimer's Activity Apron, this is a knit muff to give Alzheimer's & dementia patients something to do with their hands.

Also known as Twiddle Muffs.

Sensory Bands



If you would like to make a Sensory Band or even a few, they will be gratefully received and given to patients to keep and take home. **You can send them to: Communications; Level 4 West, NNUH Colney Lane Norwich Norfolk NR4 7UY (or leave at West Atrium Reception Level 1 fao Communications)**
Our thanks go to Blackpool Teaching Hospitals for kindly letting us use their pattern.

A sensory band is a pocket or glove that has attachments added to it, inside and out, that patients can twiddle and fiddle with.

They are used to calm patients with dementia or Alzheimer's by giving them something to do with their hands or just enjoyed by older patients.

What you need:

- 6.5mm straight needles or 8mm circular needles. (6.5 mm=size 10.5 8mm=size 11)
- Beads, zips, ribbons, anything that can be twiddled with but not break.
- Wool/yarn. Sensory Bands are perfect for using up leftover wool. A variety of textures works really well.

The above example is for guidance only and any colour wool/yarn can be used and sizes can vary.

Directions:

Make the band:

- Cast on 40 stitches using 2 strands of double knitting wool (or one strand of chunky wool).
- Work in stocking stitch (knit one, pearl one) for 11 inches (28 cm).

Continue with the body:

- Continue with stocking stitch using various textures and colours of wool.
- Knit until work measures 23 inches (58 cm).
- Cast off.

Decorate and finish:

- Attach beads, flowers, zips, loops or anything else people can fiddle with making sure they are attached firmly so they cannot easily be pulled off.
- Neatly join sides together with pearl side facing you.
- Turn inside out.
- Push the band inside the body.
- Neatly sew together the two ends.



KNIT PATTERNS

#1



SENSORY BANDS

(Also known as “Twiddle Muffs” and Alzheimer’s Activity Muffs)

Carol Caywood provided a series of photos (#1-#5) to show you how these muffs are made.

SIZE: approximately 18” x 24”
Use these measurements for a crochet version.

#2



Add beads, keys, etc.



#3



Sew lengthwise seam (tube)

Here is a man’s muff made by Carol Caywood for FMH.

Below are samples of trims that can be added to muffs. ANYTHING that keeps fingers occupied will work. The key for men is very clever!

#4



Sew crosswise seam for lined tube



#5



DONE!

KNIT PATTERNS

TINY MITTEN PATTERN

This mitten pattern for 2lb. to 4lb. Babies is reprinted with permission from Ray of Hope; the pattern was submitted to them by Mary Garratt. The web page is based in England, so some of the terms are English, but are readily understandable.. They have many interesting patterns for premature babies – you can check them out at www.rayofhope.co.uk They will measure approx. 1-1/2" x 2" for the smaller ones and 1-3/4"x 2" for the larger ones (numbers in parentheses).

Materials: 4 ply wool (USA Sport/baby Standard Yarn Weight System #2, Fine) A 50gram ball will

make a lot of mittens.

3.25 (USA #3) knitting needles.

For even smaller mittens, use 3 ply baby yarn.

Cast on 25 stitches.

Work 3 rows in moss [seed] stitch (K1, P1—starting each row with knit stitch) or work 3 rows of K1, P1 rib.

Work next 4 (10) rows in stocking stitch (Knit 1 row. Purl 1 row) beginning with a knit row.

Eyelet row: K2, *yo, K2 tog, repeat from * to last stitch, K1.

Next row: P11 stitches, P2 tog, P12. (24 stitches)

Work 8 (10) rows in stocking stitch, beginning with a knit row

Shape Top:

Row 1: K1, K3 tog, K5, K3 tog tbl, K3 tog, K5, K3 tog tbl, K1.

Row 2. Purl.

Row 3. K1, K3 tog, K1, K3 tog tbl, K3 tog, K1, K3 tog tbl, K1.

Row 4. Purl

Bind off remaining 8 stitches.

Sew side seam and top seam. Thread ribbon through eyelets.

Abbreviations:

Yo = yarn over

tbl = through back of loops

Tiny Mitten

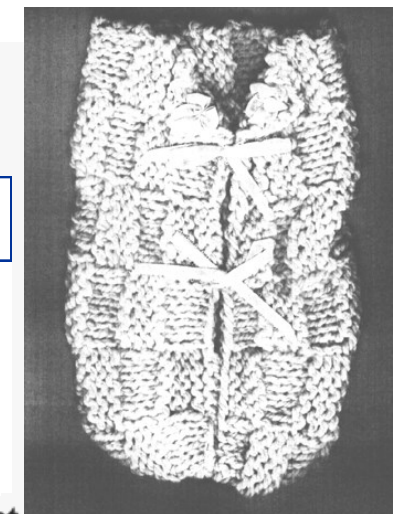

Thanks to Heather Rinkel for reviewing this pattern & editing terminology for U.S. knitters.

KNITTED BURIAL POUCH

The finished pouch measures approximately 8 1/2" long & 5-5 1/2" wide. (It is easy to adjust length & width according to the size needs of your hospital.)

Pattern designed by Elaine Pendleton for Care Wear Volunteers.

Yarn: 4-ply yarn in white, ivory, or delicate pastel colors.

Needles: Size 10

Trims: Narrow ribbon for ties, ribbon roses or other decorative trims.



DIRECTIONS:

Cast on 40 sts

Row 1: K5, P5 – across row

Row 2: K5, P5, continue this for a total of 6 rows

On 7th, reverse: P5, K5 for a total of 6 rows

Basket weave pattern:

Estimated for a total of 12-13 sets of 6 rows

Bound off sts and sew up bottom and up 2-3" front

Make 2 bows for closures and add little flowers and bows to the top of each side

For a larger size:

Cast on 60 sts. Knit 15 sets of 6 rows.

KNIT PATTERNS

IV COVERS FOR CHILDREN & ADULTS

Pediatric IV Wrist Covers

Wrist Covers cover the IVs that sometimes bother children in the hospital. They are simple knitted tubes, about 3" wide, and 6" long, with a thumb hole at about the middle

Waffle Stitch IV Wrist Cover

Worsted weight yarn, acrylic, size 6 needles

Cast On 32 (loosely, so it won't be tight around a wrist)

K2, P2 ribbing for 6 rows

Pattern Stitch: K 1 row; Purl 1 row; K2 P2 for two rows.

Repeat the 4 pattern rows 6 times. Then Knit 1 row, and Purl 1 row

K2, P2 ribbing for 6 rows

Cast off fairly loosely in rib. Sew side seam about halfway down, then leave about 2" open (for thumb hole on the side), then finish sewing the rest of the seam to the end.



OTHER SIZES:

Use the following amount of stitches:

cast on 28 sts - child's small

cast on 32 sts - child's medium

cast on 36 sts - child's large

cast on 40 sts - adult's small

cast on 44 sts - adult's medium

cast on 48 sts - adult's large

Also, add more pattern repeat rows to make the cover longer for larger sizes, and leave the thumb opening a bit larger.

Thanks to Dawn Adcock for her written permission to reprint.

SOURCE: Dawn Adcock

Dawn's Dream Designs www.dawnadcock.com

Knitting/Spinning Notebook www.3gcs.com/adcock/knittingmain.htm

Founder, Cultured Purls Knitting Guild

www.culturedpurls.com

dawn@dawnadcock.com

SHAWLS & HATS FOR ADULT CANCER PATIENTS

Ask your local hospital or cancer treatment center if patients need shawls and/or hats to keep warm during therapy sessions. Patterns for adult hats and for shawls are readily available or simply knit a rectangular shawl (approximately 20" wide x 72" long). Use a favorite stitch and perhaps attach fringe on the two short ends. The old washcloth pattern is used for blankets (page 26) and if continued, can be a lovely shawl.

REMEMBER to include colors and patterns for male patients!



CROCHET PATTERNS

CROCHET IV COVERS

Used by hospitals to cover the IV in a child's hand and make them more comfortable.

MATERIALS:

Worsted Weight Yarn
J Crochet Hook

DIRECTIONS:

Chain 21, single crochet in second chain from hook across row.

In each row thereafter, single crochet in back loop (to create a stretch), chain 1 at the end of each row.

Continue until piece is about 4 to 6 inches wide. Slip stitch halfway up, leave a space open large enough for a thumb and continue slip stitching to the top.

To finish off instead of slip stitching, the yarn can be cut leaving a tail about 15 inches and the piece can be sewn as described.

Chain less stitches and make more narrow for smaller sizes.

SIZE CHART FOR CHILDREN:

Small: 4" wide x 5 1/2" to 6" tall

Medium: 5" wide x 6" tall

Large: 6" wide x 6" tall



SHAWLS and HATS FOR ADULT CANCER PATIENTS

Ask your local hospital or cancer treatment center if patients need shawls and/or hats to keep warm during therapy sessions. Patterns for adult hats and shawls are readily available. You could just crochet a rectangular shawl (approximately 20" wide x 72" long). Use a favorite stitch and perhaps attach fringe on the short ends.

REMEMBER colors and patterns for male patients!



CROCHET PATTERNS

DOUBLE CROCHET HAT



MATERIALS: Size F hook
Baby or sport weight yarn

All rows are worked in *back loop only* (BLO); Two sizes

DIRECTIONS:

Chain loosely 28 (32); Dc in third ch from hook and in each ch across – 25 (29).
Ch 3 and turn; Continue in this pattern for 20 rows (22).
Fasten off leaving a yard long tail; Use tapestry needle to weave sides together.
Weave around the top, pulling thread tight; Whip stitch to firmly secure the crown;
Add a pom-pom or bow.

CROCHET EDGINGS: FLANNEL/FLEECE BLANKETS

For an excellent guide for making crochet edgings on flannel & fleece blankets, go to the December 2010 newsletter (pages 18-20).

CROCHET TWIDDLE MUFFS

See page 31 for dimensions and assembly details. Crochet a rectangle and assemble as shown.

SINGLE CROCHET HAT



MATERIALS:

Size F crochet hook
Sport or baby weight yarn

All rows are worked in *back loop only* (BLO) to create rib effect

There is more demand for the larger sizes shown in parentheses.

DIRECTIONS:

Chain 21 (25, 29, 32, 35) Sc in second ch from hook and in each stitch across.
Ch 1 and turn.

Remaining rows:

Sc in BLO of each stitch; ch and turn.

Continue this pattern for 30 rows (36, 42, 50, 56).

Fasten off leaving a two-foot tail; thread tail through tapestry needle; Weave in end of stitches, joining sides of row 1 and the last row.

Continue to weave around the top, pulling tightly and whip stitching to firmly secure the crown; Add a pom-pom or bow, if you wish.

CROCHET BLANKETS

Use any pattern you enjoy making. Blankets for preemies should be 30" square or larger. Blankets for full-term infants should be 36" square or larger. Hospitals request that you **NOT** use patterns that have big open spaces that catch little fingers & toes.



CROCHET PATTERNS

Preemie Hat

Crochet



SIZE: To fit preemie baby's head.

MATERIALS

Bernat® Softee Baby

(Solids 140 g/5 oz OR Ombres 120 g/4.42 oz)

1 ball

Size 4 mm (U.S. G or 6) crochet hook or **size needed to obtain gauge.**

GAUGE

18.5 sc and 19 rows = 4 ins [10 cm].

INSTRUCTIONS

Ch 49. Join in round with sl st to first ch, taking care do not twist chain.

1st rnd: Ch 1. 1 sc in each ch to end of rnd.

Join with sl st to first sc.

2nd rnd: Ch 1. 1 sc in each sc to end of rnd.

Join with sl st to first sc.

Rep last rnd for 8 ins [19 cm].

Fold hat in a half. Working through both thicknesses, ch 1. 1 sc in each sc to end of folded row. Fasten off.

Fold 2 top corners tog and sew at center of top row.

Fold bottom edge to desired depth of Hat.

Reprinted with permission in the September 2011 newsletter.

www.bernat.com

Newsletters from 2000 to current issues are available on the Care Wear Volunteers website:

www.carewear.org

Abbreviations: www.bernat.com/glossary

MITTENS

Size E hook Baby or fingering yarn

Cuff: Ch 8, sc in 2nd ch from hook; 1 sc in each ch to end; turn. (7 sc) *ch 1, sc in back loop only to end of row, turn* Repeat from * to * until strip measures 3 1/2 ". Fasten off. Sew short ends of cuff strip together to form circle.

Hand: With right sides of work facing you, join yarn to one edge of cuff at seam.

Base Rnd: Ch 1, sc 18 evenly around edge of cuff. Join with sl st to ch.

DO NOT TURN.

Rnds 2, 4, 6, 8: Ch 2, dc in back loop only to end, join with sl st to top of ch.



Rnd 3: Ch 1, (2 sc, 2 sc in next st) to end, join with sl st to ch. (24 sts in rnd)

Rnds 5, 7: Ch 1, sc to end, join with sl st to ch.

Rnd 9: Ch 1, (2 sc, 2 sc tog) to end, join with sl st to top of ch. (12 sts now in rnd)

Ch 1, sc 2 sc tog to end. Fasten off leaving a 6" tail.

Sew seam at top of mitten. Weave ribbon through the dc rnd at wrist & tie in a bow.



CROCHET PATTERNS

CROCHETED SNUGLER

This is a positioning tool for NICU infants.
(Designed by Sharri Shively. Permission given for Care Wear to use.)

MATERIALS: H hook and 3- or 4- ply worsted yarn
or approximately 4 oz baby sport or sport yarn
Acceptable finished length can be anywhere between 26" and 30"

Version One:

Begin: Ch 4, join with sl st to make a ring.

Row 1: Ch 2 (counts as first dc); dc 11 more in ring, join with sl st (12 dc)

Row 2: Ch 2 (in this row and all succeeding rows, this counts as first dc stitch); dc in same stitch as Ch 2, (this creates an increase); 2 dc in each of 11 remaining dc; join with sl st (24 dc)

Row 3: Ch 2, 1 dc in each of remaining 23 dc, join with sl st.

Row 4: Ch 2, 1 dc in each of remaining 23 dc, turn.

Row 5-52: Repeat row 4

Row 53: Repeat row 3

Row 54: Decrease from 24 dc to 12 dc (to decrease: Insert hook, yo and pull through.

Leaving yarn on hook, insert into next stitch, yo and pull through, yo and pull through 2 loops, yo and pull through 2 loops.)

Row 55: Decrease from 12 dc to 6 dc.

Row 56: Decrease from 6 dc to 3 dc; end off, leaving a 6" length of yarn. With a needle, run yarn through top loops of yarn. With a needle, run yarn through top loops of final 3 dc with a gathering stitch and pull closed. Lock stitch shut. Hide excess length of yarn inside snuggler.

Version Two:

Begin: Ch 25

Row 1: Dc in second ch from hook and in each remaining ch (24 dc); Ch 2, turn.

Row 2-56: Dc in each dc, ch 2, turn. (24 dc)

Finish off: Leaving yarn length 1½ times the length of the snuggler.

SEWING AND STUFFING THE SNUGLERS

Version One:

The ends are already rounded and fastened for you! Using piece of yarn 1½ times the length of snuggler, sew shut, using a weaving stitch. (Use 2 stitches per dc). Lay stuffing in snuggler as you sew, filling at least 1/3 to ½ at a time. The longer the piece of fiberfill, the less it will bunch when washed. Also, overlap the fiberfill ends at least 2" using a thinner thickness at the overlap edges so there isn't a bump. Finished product should feel like a very soft loaf of bread when squeezed. It will bend over when held vertically, but not flop in half. One 20 oz bag of fiberfill will stuff 8 to 10 snugglers, depending on how loosely or tightly they are crocheted.

Version Two:

On one end, using an 8" piece of yarn, run a gathering stitch through the top of each dc, draw tightly, and knot securely. Hide ends inside the snuggler. At the other end, using a piece of yarn approximately twice the length of the snuggler, gather this end as you did the first, using 8" of the yarn's end. Sew shut with weaving stitch as instructed in Version One, using the remaining length of the gathering yarn.

CROCHET PATTERNS

Leaflet LW1269

RED HEART

Gotcha Covered #2!

Crocheted hats for everyone—
choose your yarn,
choose your size.



Pattern FREE with Red Heart Yarn purchase!

© 2000 Coats & Clark

COATS & CLARK RED HEART YARN

Here is the crochet flyer from Coats & Clark that provides directions for all sizes and yarn weights. A very handy flyer to have on file!

Note that the 12" preemie size fits at least a 5-6 pound infant head. It is NOT the tiny preemie sizes needed for 1-3 pound infants.

PATTERNS on next page

PREEMIE BOOTIES



← 2 3/4" →

Baby yarn—"F" hook



← 3 1/2" →

Worsted yarn—"F" hook

MATERIALS: Size E or F hook
Baby yarn

DIRECTIONS:

Ch 16 (18, 20) st

Row 1: Sc in the back of the second ch from hook; all remaining sc are worked in back loop only for ribbed effect; Sc in back of remaining 14 (16, 18) st; ch 1 & turn

Row 2: Sc in each st across; there should be 15 (17, 19) st; ch 1 and turn

Row 3 – 20: Repeat row 2, omitting ch 1 at end of row 20; there should be 10 ridges and 10 valleys

To Form Toe:

Fold so that rows 1 and 20 face each other

Slip st rows 1 and 20 together for 7 (8, 9) st; Draw up a loop and remove hook

With a short piece of yarn and a needle, whip together the open heel to form the base of the bootie leg; Tie off end

To Make Leg:

Reinsert crochet hook in loop at instep

Ch 3, dc in each st around leg; Join with sl st; *Ch 3, dc in each dc of leg; Repeat from * once more; Join with sl st & fasten off

To Close Toe:

With a short piece of yarn and a needle, pick up the top st of each ridge of the open toe

Draw together and tie securely; Add a ribbon or ch a string to weave through ankle and tie a bow; Make the other one.

CROCHET PATTERNS

LW1269 Gotcha Covered #2 ★ Suitable for Beginners.

YARN QUALITY		CROCHET HOOKS	GAUGE in sc rnds ON SMALLER HOOK
A Fingering Weight	RED HEART® Baby Fingering Traditional RED HEART® Baby Fingering Pompadour	D-3 & E-4	21 sts = 4"; 25 rnds = 4"
B Soft Sport Weight	RED HEART® Soft Baby TLC® Baby	F-5 & G-6	18 sts = 4"; 21 rnds = 4"
C Sport Weight	RED HEART® Sport RED HEART® Super Sport RED HEART® Baby Sport Econo	G-6 & H-8	16 sts = 4"; 18 rnds = 4"
D Soft Worsted Weight	RED HEART® Soft RED HEART® Kids TLC® ultra soft Yarn	H-8 & I-9	14 sts = 4"; 16 rnds = 4"
E Worsted Weight	RED HEART® Super Saver RED HEART® Classic RED HEART® Fiesta RED HEART® Pounder	I-9 & J-10	12 sts = 4"; 14 rnds = 4"
F Bulky Weight	RED HEART® Light & Lofty RED HEART® Baby Clouds	N-15 & P-16	5 sts = 3"; 8 rnds = 4 1/4"

Amount: One skein each of 2 colors of any yarn quality will make one or more hats.

SIZE	1	2	3	4	5	6
TO FIT	Premie	Baby	Toddler	Child	Women	Men
CIRCUMFERENCE	12"	14"	16"	18"	20"	22"

NOTE: Circle the numbers appropriate to the hat size and yarn quality you are making to help keep track of the pattern.

HAT-Cuff: With **larger** hook and first color, chain

A	64	72	84	-	-	-
B	52	64	72	80	92	100
C	48	56	64	72	80	88
D	40	48	56	64	68	76
E	36	40	48	56	60	68
F	-	24	28	32	32	36

sts; join with a sl st to first ch, being sure ch is not twisted. **Rnd 1:** Ch 1, sc in same ch as joining and in each ch around; join in the back lp of first sc; **turn** — the number of sc should be the same as the number of ch. **Rnd 2:** Ch 1, sc in back lp of each sc around; join in back lp of first sc; turn. Rep Rnd 2 for

A-F	2 1/2	3	4	5	6	6
------------	-------	---	---	---	---	---

inches, do not turn at end of last rnd. **Crown:** Change to **smaller** hook and second color. **Next Rnd (Right Side):** Ch 1, sc in both lps of each sc around; join; do **not** turn. Rep last rnd with one color or 2 colors for stripes until

A-F	5	6	7	9	10	10
------------	---	---	---	---	----	----

inches from beg. **Shape Top:** Ch 1; [draw up a lp in next 2 sc, yo and draw through all 3 lps on hook — **dec** made; sc in next

A	11	13	16	-	-	-
B	8	11	13	15	18	20
C	7	9	11	13	15	17
D	5	7	9	11	12	14
E	4	5	7	9	10	12
F	-	1	2	3	3	4

sts, dec, sc in next sc, place marker in last st] 4 times; join to first sc — 8 sts dec. **Next Rnd:** Ch 1, [dec, sc in each sc to 2 sts before marked st, dec, sc in next sc] 4 times; join. Rep the last rnd until the rnd "Ch 1, [dec, sc in next 0 **OR** 1 sc, dec, sc in next sc] 4 times" has been worked and 12 **OR** 16 sts rem. Work 1 rnd even. Cut yarn, leaving a long end; weave through rem sts, draw up tightly and fasten securely. Fold cuff in half to the right side. **Optional:** Make a pom pom and fasten to top of hat.

ABBREVIATIONS: beg = beginning; ch = chain; dec = decrease(d); lp = loop; rem = remain(ing); rep = repeat; rnd = round; sc = single crochet; sl = slip; st = stitch; tog = together; yo = yarn over; * = repeat whatever follows the * as indicated; [] = work directions given in brackets the number of times specified.



CROCHET PATTERNS



LION BRAND® BABYSOFT SO-SOFT PREMIE HAT

SIZE: Small Premie (Medium Premie, Large Premie)

FINISHED CIRCUMFERENCE: 6 (7, 8) inches

FINISHED LENGTH: 3 3/4" (5, 5 1/2")

Hat is stretchy & will fit a range of sizes.

MATERIALS

- 920-100 Lion Brand Babysoft: White
1 Skein: Makes 8 - 9 hats
- Lion Brand Crochet Hook - Size G-6
- Lion Brand Stitch Markers
- Large-Eye Blunt Needle

Note: If you opt to use worsted weight yarn for this pattern, switch to size "H" or "I" hook.

GAUGE:

4 sc = 1 in. [2.5 cm] BE SURE TO CHECK YOUR GAUGE.

NOTES:

Crown is worked in rnds, do not join. Place marker to indicate beg of rnd. Move marker up each rnd

HAT

Crown

Ch 2.

Rnd 1 (right side): Work 6 (7, 8) sc in 2nd ch from hook; do not join.

Rnd 2: 2 sc in each sc around - 12 (14, 16) sc.

Rnd 3: *Sc in next sc, 2 sc in next sc; repeat from * around - 18 (21, 24) sc.

Rnd 4: *Sc in next 2 sc, 2 sc in next sc; repeat from * around - 24 (28, 32) sc.

Sides

Note: Sides are worked in a spiral, do not use marker.

Pattern: *Sc in back loop only of next sc, sc in front loop only of next 2 sc; repeat from * until piece measures 3 1/2 (4 3/4, 5 1/4) in. [9 (12, 13.5) cm] from beg.

Last Rnd: Sc in next 24 (28, 32) sc, slip stitch in next sc. Fasten off.

CORD (for top knot)

Join yarn in top of Hat, ch 11.

Row 1: Sc in 2nd ch from hook and each ch across, join to Hat with slip stitch - 10 sc. Fasten off.

FINISHING

Weave in ends. Knot cord. Turn up lower edge of Hat to form cuff.

ABBREVIATIONS/ REFERENCES

Beg = begin(s) (ning) ch(s) = chain(s)
 Rnd (s) = round(s) sc = single crochet
 St(s) = stitches

www.lionbrand.com



Small premie—"G" hook



Larger size—"G" hook

The Care Wear "tester" who made the samples shown above, suggested adding (3,3) to maintain the pattern of ridges visible in the SMALL PREMIE light blue hat. She suggested

"...next 2 (3,3) sc;"



IF you use 3 sc for the larger sizes, you hat will have this ribbed effect—like the light blue hat.

CAPS AND BOOTIES



EASY

This crocheted stocking cap and booties can be made for premature, newborn and 3 to 6 month olds.

You will need ½ ounce Coats & Clark's "Red Heart Sofspun" baby yarn in blue and white, sizes E, F and G crochet hooks.

Gauge: Using size F crochet hook,
5 sc equal 1 inch
6 sc rows equal 1 inch

Note: Size E crochet hook is used for premature size.

Size F crochet hook is used for newborn size.

Size G crochet hook is used for 3-6 month size.

All rows are worked in the **Back Loop Only (blo)** of each st to create ribbing for stretchability.

You may alternate colors, working two rows of blue, two rows white. When

changing colors, work new color into last two lps of ending sc of previous color.

Do not fasten off when changing color; carry across.

CAP: With blue yarn, ch 35.

Row 1: Sc in second ch from hook, sc in each st across. Ch 1, turn – 34 scs.

Rows 2-56: Sc in blo of each st across. Ch 1, turn – 34 scs.

Using tapestry needle, weave remaining yarn in end st of every other row along the 56 row portion, pull thread tightly and whipstitch to firmly secure top of cap crown. Do not fasten off. Hold wrong side of Row 1 and right side of Row 56 tog, sl st with crochet hook, or use tapestry needle and go through the blo of Row 56, matching the 34 corresponding sts. Fasten off, weave in end. Make small pompom for crown, or crochet a rosette.

ROSETTE: Ch 9, dc in 4th st from hook, 9 dc in same sp. Work 10 dc in each remaining st. Fasten off, pull both strands of yarn to wrong side of cap and knot several times. Rosette may be secured more firmly by stitching edges in several places.

18 • The WORKBASKET

This classic and well-designed pattern was printed in The Workbasket, a wonderful magazine.

BOOTIES: Leg: Ch 15.

Row 1: (Wrong side of work) Sc in second ch from hook, sc in each st across. Ch 1, turn – 14 scs.

Rows 2-20: Sc in blo of each st across. Ch 1, turn – 14 scs. At end of Row 20, do not fasten off.

Instep: With edge facing where color is carried across, join in end st of 8th row of leg.

Row 1: Ch 1, sc in same st as joining sc in end st of next 4 rows. Ch 1, turn – 5 scs.

Rows 2-7: Sc in blo of each st across. Ch 1, turn – 5 scs. (At end of Row 7, do not ch-1.) Fasten off, weave ends on wrong side.

Foot: Pick up working yarn. Sc in end st of next 8 rows of leg, sc in end st of next 7 rows of instep, sc in blo of next 5 scs. Sc in end st of next 7 rows of instep, sc in end st of next 8 rows of leg. Ch 1, turn – 35 scs.

Rows 2-7: Sc in blo of each st across. Ch 1, turn – 35 scs.

Row 8: Sk first st, sc in blo of next 14 sts, (sk one st, sc in blo of next st) 3 times, sc in blo of next 12 sts, sk one st, sl st in last st. Ch 1, turn – 29 scs.

Row 9: Sk first st, sc in blo of next 11 sts, (sk one st, sc in blo of next st) 3 times, sc in blo of next 10 sts. Sk one st, sl st in last st. Ch 1, turn – 24 scs.

Row 10: Sk first st, sc in blo of next 12 sts. With right sides facing sl st corresponding sts of bottom edges tog. Whipstitch remaining portion of foot and leg in same manner as cap. Fasten off, weave in ends. 🐾

FINGER PUPPETS

Use a size 1 or "B" crochet hook Baby or fingering yarn.

Ch 13 stitches

Row 1: Sc in the second chain from hook and in each chain across (12 sc); Ch 1 and turn.

Row 2-11: Sc in each stitch across going through both loops of each sc.

Finished piece measures about 1 5/8" wide x 1 1/2" long.

Fasten off leaving a tail of about 5".

While piece is flat, embroider eyes, nose, and mouth with embroidery floss or use liquid paint.

Use the tail to weave the back closed and gather the top, which is the last row of sc.

1/8" ribbon makes a cute bow for the top of girl puppets; for boy puppets, try changing the yarn color after six rows to look like a hat. Alternately, you could use a small pompom or floss for hair. Good face colors would be white, pink, peach, or brown.

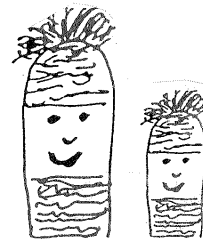

REPRINTED FROM THE DECEMBER 2003 NEWSLETTER



CROCHET

FROM HEART TO HOOK

HAPPINESS IS...
A BOX FULL OF HATS!
DECEMBER 2003

Dear Friends,

Crochet is a wonderful and versatile craft and unlike its cousin, knitting, it is not limited to going back and forth in rows. One advantage knitting does seem to have is that it is much less bulky and it is sometimes easier to make a soft garment with it. And the softer the better when making things for our tiny babies.

Most of us have bags and boxes full of leftover worsted weight yarn that we would love to use for our baby projects. Unfortunately some of us have had the frustrating experience of having the finished piece turn out to be so stiff that we cannot use it. But worsted weight yarn can be used to make wonderful things for babies! The secret is to use a large enough hook that will keep the crochet nice and soft. The smaller the hook, the tighter (or stiffer) the finished piece will be.

The following hat patterns are made using a loose **gauge** (the number of stitches per inch of crochet). They are super quick to make and I know you'll think of lots of fun ways to change them and make them special. And the best part is that they use very small amounts of yarn and will put all of your scrap yarn to a very good use!

I hope that you enjoy the patterns.

Terry

Abbreviations used:

ch(s)	chain(s)
dc	double crochet
FPdc	Front Post double crochet
hdc	half double crochet
Rnd(s)	Round(s)
sc	single crochet
st(s)	stitch(es)
YO	yarn over

BASIC HAT PATTERNS

There are five basic hat patterns and any of them can be made in a solid color and used just as they are. But if you're in the mood to add a little something to them, try any of the 15 designs that begin with the basic patterns.

MATERIALS

Redheart Worsted Weight or any worsted weight yarn that works to gauge (most hats use small amounts of yarn, but I didn't list the yarn amounts because of the extra amount of space it would require—I needed that space for more hat patterns!)

Crochet hooks sizes I and G or size needed for gauge
Yarn needle and embroidery needle

SIZES

Size Small: approximately 8"

Size Medium: approximately 10"

Size Large: approximately 11"

Note: Instructions are written for size Small with instructions for Medium and Large in parentheses.

Most of the hats will work well in any size, but you may want to use a smaller size hook to make some of the "extras" (use the larger hook for the basic hat).

TO MAKE A GAUGE SWATCH

With **larger** size hook, ch 4; join with slip st to first ch to form a ring.

Rnd 1: Ch 3 (counts as first dc now and throughout), work 11 dc in ring; join with slip st to first dc: 12 dc.

Rnd 2: Ch 3, dc in same st as joining, 2 dc in each dc around; join with slip st to first dc: 24 dc.

Rnd 3: Ch 3, 2 dc in next dc, work (dc in next dc, 2 dc in next dc) around; join with slip st to first dc: 36 dc.

This piece should measure 4" across. If it doesn't, you'll need to start over and try a different size hook.

If it measured **less** than 4", try a **larger** size hook.

If it measured **more** than 4", try a **smaller** size hook.

When your piece measure 4" then you are ready to go and the good news is that you have finished the first 3 rounds of Basic Hat #1, size Large!

CROCHET PATTERNS

BASIC HAT #1

Ch 4; join with slip st to first ch to form a ring.

Rnd 1: Ch 3 (counts as first dc, now and throughout), work 11 dc in ring; join with slip st to first dc: 12 dc.

Rnd 2: Ch 3, dc in same st, 2 dc in each dc around; join with slip st to first dc: 24 dc.

SIZE MEDIUM ONLY-Rnd 3: Ch 3, dc in next dc, 2 dc in next dc, (dc in next 2 dc, 2 dc in next dc) around; join with slip st to first dc: 32 dc.

SIZE LARGE ONLY-Rnd 3: Ch 3, 2 dc in next dc, work (dc in next dc, 2 dc in next dc) around; join with slip st to first dc: 36 dc.

Rnds 3(4-4)-5(6-7): Ch 3, dc in next dc and in each dc around; join with slip st to first dc.

Ribbing

Ch 3(4-5) loosely.

Row 1: Sc in second ch from hook and in next 1(2-3) chs: 2(3-4) sc.

Row 2: Slip st in next 2 dc on hat, **turn**; skip slip sts, sc in back loop only of next 2(3-4) sc: 2(3-4) sc.

Row 3: Ch 1, **turn**; sc in next 2(3-4) sc.

Rows 4-23(31-35): Repeat Rows 2 and 3, 10(14-16) times.

Row 24(32-36): Slip st in next dc and in same st as joining, **turn**; skip slip sts, sc in next 4 sc; finish off leaving a length for sewing.

Sew ends of ribbing together.

BASIC HAT #2

Ch 4; join with slip st to first ch to form a ring.

Rnd 1: Ch 2, work 8 hdc in ring; join with slip st to first hdc (do not count ch-2 as an hdc, now and throughout): 8 hdc.

Rnd 2: Ch 2, work (hdc in next hdc, 2 hdc in next hdc) around; join with slip st to first hdc: 12 hdc.

Rnd 3: Ch 2, work 2 hdc in each hdc around; join with slip st to first hdc: 24 hdc.

SIZE MEDIUM ONLY-Rnd 4: Ch 2, work (hdc in next 2 hdc, 2 hdc in next hdc) around; join with slip st to first hdc: 32 hdc.

SIZE LARGE ONLY-Rnd 4: Ch 2, work (hdc in next hdc, 2 hdc in next hdc) around; join with slip st to first hdc: 36 hdc.

Rnds 4(5-5)-7(9-10): Ch 2, work hdc in each hdc around; join with slip st to first hdc.

Ribbing: Work same as Ribbing for Basic Hat #1.

BASIC HAT #3

Ch 4; join with slip st to first ch to form a ring.

Rnd 1: Ch 1, work (sc, dc) 5 times in ring; join with slip s to first sc: 10 sts.

Rnd 2: Ch 3, **turn**: work (sc, dc) in same st as joining, sc in next dc, * work (dc, sc, dc) in next sc, sc in next dc; repeat from * around; join with slip st to first dc: 20 sts.

SIZE SMALL ONLY-Rnd 3: Ch 1, **turn**; sc in first dc, work (dc in next sc, sc in next dc) 4 times, work (dc, sc, dc) in next sc, * sc in next dc, work (dc in next sc, sc in next dc) 4 times, work (dc, sc, dc) in next sc; repeat from * around; join with slip st to first sc: 24 sts.

SIZE MEDIUM ONLY-Rnd 3: Ch 1, **turn**; sc in first dc, work (dc in next sc, sc in next dc) 3 times, work (dc, sc, dc) in next sc, * sc in next dc, work (dc in next sc, sc in next dc) twice, work (dc, sc, dc) in next sc; repeat from * around; join with slip st to first sc: 26 sts.

SIZE LARGE ONLY-Rnd 3: Ch 1, **turn**; sc in first dc, dc in next sc, sc in next dc, work (dc, sc, dc) in next sc, * sc in next dc, dc in next sc, sc in next dc, work (dc, sc, dc) in next sc; repeat from * around; join with slip st to first sc: 30 sts.

SIZE LARGE ONLY-Rnd 4: Ch 3, **turn**; sc in next dc, (dc in next sc, sc in next dc) 3 times, * work (dc, sc, dc) in next sc, sc in next dc, (dc in next sc, sc in next dc) 4 times; repeat from * twice, sc in last dc; join with slip st to first dc: 36 sts.

Rnd 5: Ch 1, **turn**; sc in same st as joining, dc in next sc, (sc in next dc, dc in next sc) around; join with slip st to first sc.

Rnd 6: Ch 3, **turn**; sc in next dc, (dc in next sc, sc in next dc) around; join with slip st to first dc.

Rnds 7-11: Repeat Rnds 5 and 6 twice, then repeat Rnd 5 once more.

Ribbing: Work same as Ribbing for Basic Hat #1.

BASIC HAT #4

Ch 18(22-26) loosely.

Rnd 1 (Right side): Hdc in third ch from hook and in each ch across: 16(20-24) hdc (do not count ch-2 as an hdc, now and throughout).

Rnds 2-16(20-24): Ch 2, **turn**; hdc in back loop only of each hdc across.

Finish off leaving a length for sewing. With **right** sides together, sew beginning chain and last row together through one loop on each side (so it will be a nice flat seam); stitch in place several times, but do not cut yarn.

Weave yarn end through end of each row, pulling tightly to gather and close the top. Secure end and finish off. Turn lower edge of hat to the right side to form the brim.

CROCHET PATTERNS

BASIC HAT #5

Ch 4; join with slip st to first ch to form a ring.

Rnd 1: Ch 3 (counts as first dc, now and throughout), work 11 dc in ring; join with slip st to first dc: 12 dc.

Rnd 2: Ch 3, dc in same st, work FPdc around the post of next dc, * 2 dc in next dc, work FPdc around the post of next dc; repeat from * around; join with slip st to first dc: 18 sts.

SIZE SMALL ONLY-Rnd 3: Ch 3, dc in same st, dc in next dc, work FPdc around post of next FPdc, * 2 dc in next dc, dc in next dc, work FPdc around post of next dc; repeat from * around; join with slip st to first dc: 24 sts.

SIZES MEDIUM AND LARGE ONLY-Rnd 3: Ch 3, dc in same st, 2 dc in next dc, work FPdc around post of next FPdc, * 2 dc in next 2 dc, work FPdc around post of next dc; repeat from * around; join with slip st to first dc: 30 sts.

SIZE LARGE ONLY-Rnd 4: Ch 3, dc in same st, dc in next 4 dc, work FPdc around post of next FPdc, * 2 dc in next dc, dc in next 4 dc, work FPdc around post of next FPdc; repeat from * around; join with slip st to first dc: 36 dc.

Rnds 4(4-5)-5(6-8): Ch 3, dc in next 4 dc, work FPdc around post of next FPdc, * dc in next 5 dc, work FPdc around post of next FPdc; repeat from * around; join with slip st to first dc.

Rnds 6(7-9)-8(9-11): Ch 3, work FPdc around post of next st, * dc in next dc, work FPdc around post of next st; repeat from * around; join with slip st to first dc. Finish off.



DADDY'S BOY

Using Redheart Worsted Weight yarn "Camouflage", make a hat using any of the Basic Hat patterns.



LITTLE SWEETHEART

Make a hat following any of the basic patterns.

Large Heart (for Large or Medium size hats)

Row 1: With Red, ch 2, sc in second ch from hook: 1 sc.

Row 2: Ch 1, turn; 3 sc in sc: 3 sc.

3 sc.

Row 3: Ch 1, turn; 2 sc in first sc, sc in next st, 2 sc in next sc: 5 sc.

Row 4: Ch 1, turn; 2 sc in first sc, sc in next 3 sc, 2 sc in last sc: 7 sc.

Row 5: Ch 1, turn; sc in each sc across.

Row 6: Ch 1, turn; 2 sc in first sc, sc in next 5 sc, 2 sc in last sc: 9 sc.

Row 7: Repeat Row 5.

Row 8: Ch 1, turn; sc in first 5 sc, leave remaining sc unworked: 5 sc.

Row 9: Ch 1, turn; skip first sc, sc in next 4 sc: 4 sc.

Row 10: Ch 1, turn; skip first sc, pull up a loop in each of next 3 sc, YO and draw through all 4 loops on hook; finish off: 1 st.

Second Half-Row 8: With **right** side facing, join Red with slip st in center st of Row 7, sc in next 4 sc: 5 sc.

Rows 9 and 10: Repeat Rows 9 and 10 of first half.

Large Leaf (Make 2)

With Green, ch 4, slip st in second ch from hook, hdc in next ch, work (dc, ch 3, slip st) in last ch; finish off leaving a length for sewing.

SMALL HEART

Work same as Large Heart through Row 5.

Row 6: Ch 1, turn; sc in first 4 sc, leave remaining sc unworked: 4 sc.

Row 7: Work same as Row 10 of Large Heart.

Rows 6 and 7: Repeat Rows 6 and 7 of first half.

SMALL LEAF (Make 2): With Green, ch 3, slip st in second ch from hook, work (sc, ch 2, slip st) in last ch; finish off.

Sew Heart and Leaves to hat as shown.

Other crochet patterns available in newsletters on <http://www.carewear.org>
 BIBS—March 2011 (p. 20 & 22), December 2010 (p. 29),
 December 2004 (p. 36), June 2003 (p. 6 & 8), March 2000 (p. 10)
 BLANKETS—Terry Kimbrough Crochet Column June 2004.



ROSY POSY

With Light Brown, make Basic Hat #4.

Large Rose

With Light Pink and using

smaller size hook, ch 4; join with slip st to first ch to form a ring.

Rnd 1: Ch 1, work (sc, ch 4) 4 times in ring; join with slip st to first sc: 4 ch-4 sps.

Rnd 2: Ch 1, work (sc, 3 dc, sc) in each ch-4 sp around; join with slip st to first sc: 4 Petals.

Rnd 3: Ch 1, sc in same st, ch 3, keeping petals to front of work, sc in back of first petals, ch 3, (sc between petals, ch 3) around; join with slip st in first sc: 5 ch-3 sps.

Rnd 4: Repeat Rnd 2.

Finish off leaving a length for sewing. Twist first petal made to form center petal and sew in place.

Large Leaf: Ch 7, 2 dc in fourth ch from hook, dc in next ch, hdc in next ch, 3 sc in last ch, working in free loops of beginning ch, hdc in next ch, dc in next ch, 2 dc in next ch; join with slip st to top of beginning ch, finish off.

Optional for Size Small Hat:

Small Rose: With Light Pink and using smaller size hook, ch 15, sc in third ch from hook, * skip next ch, work (sc, ch 3, sc) in next ch; repeat from * across, finish off. Roll petals into Rose shape and stitch into place.

Small Leaf: Work same as Small Leaf for Little Sweet-heart.



UPPSIE DAISY

With Light Blue, make Basic Hat #2 or any basic hat.

Daisy: With White and using smaller size hook, ch 6, slip st in second ch from hook, ch 3, skip next 3 chs, slip st in next ch (the center ch), (ch 5, slip st in second ch from hook, ch 3, slip st in center ch) 5 times; finish off.

Leaves: With Green and using smaller size hook, ch 6, slip st in second ch from hook, ch 3, skip next 3 chs, slip st in next ch, ch 10, slip st in second ch from hook, ch 3, skip next 3 chs, slip st in next ch; finish off.

Place leaves behind daisy and sew in place. With Yellow, embroider French knots in center of daisy.



LADYBUG, LADYBUG

With Black, ch 4; join with slip st to first ch to form a ring.

Rnds 1 and 2: Work same as Rnds 1 and 2 of Basic Hat #1.

Rnds 3 and 4: Ch 1, sc in each st around; join with slip st to first sc, finish off.

Rnd 5: With right side facing, join Red with slip st in

same st as joining, ch 3, 2 dc in next sc, (dc in next sc, 2 dc in next sc) around; join with slip st to first dc: 36 dc.

Rnds 6-10: Ch 3, dc in next dc and in each dc around; join with slip st to first dc.

Ribbing: Work same as for Basic Hat #1.

Dot (Make 6): With Black, ch 2, 4 sc in second ch from hook; join with slip st to first sc, finish off leaving a length for sewing: 4 sc.

Antennae: With Black, ch 22 **very tightly**, finish off.

With Black, embroider center line. Sew dots in place. Insert antennae through top of head and stitch through center.



PLEASE BEE MINE

(Size Large ONLY) Work same as Ladybug through Rnd 4, do not cut Black.

Rnd 5: With right side facing, join Yellow with slip st in same st as joining, ch 3, 2 dc in next sc,

(dc in next sc, 2 dc in next sc) around; join with slip st to first dc: 36 dc.

Rnd 6: Ch 3, dc in next dc and in each dc around; join with slip st to first dc, do not cut Yellow.

Rnds 7 and 8: Ch 3, dc in next dc and in each dc around; join with slip st to first dc.

Rnds 9 and 10: With Yellow, ch 3, dc in next dc and in each dc around; join with slip st to first dc, cut Yellow.

Ribbing: With Black, work same as Ribbing for Basic Hat #1.

Eye (Make 2): With White, ch 2, 6 sc in second ch from hook; join with slip st to first sc, finish off leaving a length for sewing. Sew eyes to hat. Embroider black dot in center of each eye.



PRETTY KITTY

Make a hat following any of the Basic hat patterns.

Ear (Make 2)

Row 1: With White, ch 2, 3 sc in second ch from hook: 3 sc.

Row 2: Ch 1, 2 sc in first sc, sc in next sc, 2 sc in next sc: 5 sc.

Edging: Sc evenly around ear; finish off leaving a length of yarn for sewing.

Eye (Make 2): With Black, ch 2, work 6 sc in second ch from hook; join with slip st to first sc, finish off leaving a length of yarn for sewing.

Nose: With Pink, ch 5, YO, insert hook in fourth ch from hook and pull up a loop, YO and draw through 2 loops on hook, YO, insert hook in last ch and pull up a loop, YO and draw through 2 loops on hook, YO and draw through all 3 loops on hook; finish off leaving a length of yarn for sewing.

Sew Ears, eyes and nose to hat and embroider mouth.



MR. FROGGIE

With Green, make a hat using any Basic Hat pattern.

Eye (Make 2)

With White, ch 4; join.

Rnd 1: Ch 3, work 11 dc in ring; join with slip st to first dc: 12 dc.

Rnd 2: Ch 1, sc in same st and in each dc around; join with slip st to first sc.

Rnd 3: Ch 2, dc in next dc, * (YO, insert hook in next st and pull up a loop, YO and draw through 2 loops on hook) twice, YO and draw through all 3 loops on hook; repeat from * around, join with slip st to first dc; finish off leaving a length for sewing.

Stuff very lightly.

Pupil: With Black, ch 2, work 4 sc in second ch from hook; join with slip st to first sc, finish off leaving a length for sewing.

Sew pupil to eye and sew an eye to each side of hat.



CUPCAKE SWEETIE

With White, make Basic Hat #1 through Rnd 4.

Rnd 5: Working in **front loop only**, ch 1, sc in same st as joining, skip 2 dc, 5 dc in next dc, skip 2 dc, * sc in next dc, skip

next 2 dc, 5 dc in next dc, skip next 2 dc; repeat from * around; join with slip st to first sc, finish off.

Rnd 6: With **right side facing** and working in free loops, join Brown with slip st in same st as joining, ch 3, dc in each dc around; join with slip st to first dc.

Rnds 7 and 8: Ch 3, dc in next dc and in each dc around; join with slip st to first dc.

Ribbing: Work same as Ribbing for Basic Hat #1.

Cherry-Rnd 1: With Red, ch 4, work 11 dc in fourth ch from hook; join with slip st to top of beginning ch: 12 sts.

Rnd 2: Ch 2, hdc in each dc around; join with slip st to first hdc; finish off leaving a length for sewing.

Add a small amount of stuffing (or scrap yarn). Thread needle with yarn end and weave through remaining sts; pull tightly to close and secure end. Sew cherry to top of cupcake.

Optional: Embroider pastel colored "sprinkles" on top of cupcake.



ITTY BITTY BEANIE

Work same as Basic Hat #4 working 4 rows each in the following order: red, yellow, blue, red, yellow, blue. Finish off. Follow instructions for Basic Hat #4 to complete.

Spinner: With Green and using smaller size hook, * ch 13, dc in fourth ch from hook and in next 5 chs, hdc in next 3 chs, sc in last ch; repeat from * once more, finish off leaving a length for sewing. Sew spinner to top of hat.

Button: With Red and using smaller size hook, ch 2, work 6 sc in second ch from hook; join with slip st to first sc, finish off leaving a length for sewing. Sew button to top of hat over spinner.



SWEET SMILEY

With Yellow, make a hat using any Basic Hat.
Eye (Make 2): With Black, ch 2, 6 sc in second ch from hook; join with slip st to first sc, finish off leaving a length for

sewing.

Mouth: With Black, ch 15, slip st loosely in second ch from hook and in each ch across; finish off leaving a length for sewing.

Shape eyes and sew eyes and mouth to hat as shown.



LITTLE PUMPKIN

With Orange, make a hat using any Basic Hat

Eye (Make 2)

Row 1: With Black, ch 2, sc in second ch from hook: 1 sc.

Row 2: Ch 1, turn; 3 sc in sc: 3 sc.

Row 3: Ch 1, turn; 2 sc in first sc, sc in next sc, 2 sc in last sc; finish off leaving a length for sewing: 5 sc.

Mouth: With Black, ch 14, slip st in second ch from hook, sc in each ch across to last ch, slip st in last ch; finish off leaving a length for sewing.

Sew eyes and mouth to hat.



SANTA'S LITTLE ELF

Make same as Basic Hat #2 beginning with Red and alternating rows of Red and White.

Ribbing: With Green, work same as Ribbing for

Basic Hat #1, do not finish off.

Last row: Ch 1, slip st in end of first row, work (ch 3, sc in third ch from hook) across; finish off leaving a length for sewing.

Sew ends of ribbing together.



SILLY SNOWMAN

With Black, work same as Rnds 1-5 of Basic Hat #3. Finish off.

Rnd 6: With **wrong** side facing, join White with slip st in same st as joining, ch 3, sc in next dc, (dc in

next sc, sc in next dc) around; join with slip st to first dc.

Rnds 7-11: Work same as Basic Hat #3.

Finish off.

Ribbing

Rnd 1: With right side facing, join Red in same st as joining, ch 5, sc in second ch from hook and in next 3 chs: 4 sc.

Complete same as Ribbing for Basic Hat #1.

Hat Brim

Rnd 1: With right side and top of hat toward you, skip first 10 sts from joining, working around the stitches, sc around the next 18 sts of last rnd of Black sts: 18 sts.

Rnd 2: Ch 1, turn; sc in first sc, dc in next sc, 2 dc in next 14 sc, dc in next sc, sc in last sc: 32 sts.

Rnd 3: Slip st loosely in each st across; finish off.

Eye (Make 2): With Black, ch 2, 6 sc in second ch from hook; join with slip st to first sc, finish off leaving a length for sewing.

Nose: With Orange, ch 5, slip st in second ch from hook, sc in next ch, hdc in last 2 chs; finish off leaving a length of yarn.

Sew Eyes and Nose to hat.



HO HO HO

With Red, make Basic Hat #1, 2, OR 3.

Ribbing

Change to White and work the same as Basic Hat #1.

With White, make pom-pom and sew to top of hat.

Thank you for making the world a better place with your loving hearts and busy hooks. God Bless.

TO MY SWEETHEART BLANKET

With White and using larger size hook, ch 74 loosely.

Row 1 (Right side): Insert hook into second ch from hook and pull up a loop, insert hook in next ch and pull up a loop, YO and draw through all 3 loops on hook, ch 1, * (insert hook in next ch and pull up a loop) twice, YO and draw through all 3 loops on hook, ch 1; repeat from * across to last ch, sc in last ch; 73 sts (counting ch-1 as a st).

Row 2: Ch 1, turn; * (insert hook in next st and pull up a loop) twice, YO and draw through all 3 loops on hook, ch 1; repeat from * across to last st, sc in last st.

Rows 3-73: Repeat Row 2.

Edging—Rnd 1: Sc in corner (mark each corner st), working in end of rows, work 69 sc evenly spaced across to next corner, sc in corner, working in free loops of beginning ch, work 69 sc evenly spaced across to next corner, sc in corner, working in end of rows, work 69 sc evenly spaced across to next corner, sc in corner, work 69 sc evenly across to first corner; join with slip st to first corner sc; 280 sc.

Rnd 2: Ch 3, work 8 dc in same st, skip next 2 sc, slip st in next sc, sc in next 3 sc, slip st in next sc, skip next 2 sc, work [7 dc in next sc, skip next 2 sc, slip st in next sc, sc in next 3 sc, slip st in next sc, skip next 2 sc] across to next corner sc, * work 9 dc in corner sc, skip next 2 sc, slip st in next sc, sc in next 3 sc, slip st in next sc, skip next 2 sc, work [7 dc in next sc, skip next 2 sc, slip st in next sc, sc in next 3 sc, slip st in next sc, skip next 2 sc] across to next corner sc; join with slip st to first sc, finish off.

Rnd 3: With right side facing, join Pink with

slip st in same st as joining, ch 4, * dc in next dc, (ch 1, dc in next dc) across to next sc, skip next sc, slip st in next sc; repeat from * around; join with slip st to third ch of beginning ch, finish off.

Heart (Make 4)

Row 1 (Right side): With Pink and using smaller size hook, ch 2, 3 sc in second ch from hook; 3 sc.

Rows 2-4: Ch 1, turn; 2 sc in first sc, sc in each sc across to last sc, 2 sc in last sc; 9 sc.

Row 5: Ch 1, turn; sc in each sc across.

Rows 6-8: Repeat Rows 2 and 3 once; then repeat Row 2 once more.

Row 9: Ch 1, turn; sc in first 7 sc, leave remaining sc unworked; 7 sc.

Row 10: Ch 1, turn; work sc decrease, sc in next 3 sc, work sc decrease; 5 sc.

Row 11: Ch 1, turn; work sc decrease, sc in next sc, work sc decrease; 3 sc.

Row 12: Ch 1, turn; sc in each sc; finish off.

Second Half-Rnd Row 9: With right side facing, join Pink with sc in same st as last sc worked at center, sc in next 6 sc; 7 sc.

Rows 10-12: Repeat Rows 10-12 of First Half.

Leaf (Make 8): With Green and using smaller size hook, ch 9 loosely, 2 dc in fourth ch from hook, dc in next 2 chs, hdc in next 2 chs, 3 sc in last ch, working in free loops of beginning ch, hdc in next 2 chs, dc in next 2 chs, 3 dc in next ch; join with slip st to top of beginning ch, finish off.

Sew a Heart and pair of Leaves to each corner of the blanket as shown.



©Terry Kimbrough 2004



Finished Size: Approximately 25" square

Worsted Weight Yarn: 10 oz. White, 2 oz. Pink, 1 oz. Green
Crochet hooks, sizes J and G or size needed to obtain gauge
Needles for yarn ends and sewing

GAUGE: Using larger size hook, 13 sts = 4"

Designed by Terry Kimbrough for the Care Wear Volunteers 2005 calendar.

CROCHET PATTERNS

BURIAL GOWN SET *reprinted from the September 2004 newsletter*



Materials

Bernat Softee Baby or any sport weight baby yarn that will work to gauge
1/4" satin ribbon

Buttons or appliqués, if desired
Crochet hook, size H or size needed for gauge

Finished Chest Size: 11 "

Try using fingering weight baby yarn for a smaller preemie size, or a very soft worsted weight for a full term baby size. Never hesitate to change a pattern or adapt it to work with the supplies you have on hand and the yarns you love to use. Just remember to keep it nice and soft for baby and always attach any buttons or trims securely.

GAUGE

Working in pattern of one row of sc and one row of dc:

20 sts = 4"

If your swatch is smaller than 4", change to a larger size hook and try again.

If your swatch is larger than 4", change to a smaller size hook and try again.

(Website: <http://www.carewear.org>)

BONNET/ HAT

Ch 4; join with slip st to form a ring.

Rnd 1: Ch 3, work 11 dc in ring; join with slip st to first dc: 12 dc.

Rnd 2: Ch 3, dc in same st as joining, 2 dc in each dc around; join with slip st to first dc: 24 dc.

Rnd 3: Ch 3, 2 dc in next dc, (dc in next dc, 2 dc in next dc) around; join with slip st to first dc: 36 dc.

Rnd 4: Ch 3, dc in next dc, 2 dc in next dc, (dc in next 2 dc, 2 dc in next dc) around; join with slip st to first dc: 48 dc.

Row 5: Slip st in next dc, work (slip st, ch 1, sc) in next dc, work (skip next 2 dc, 5 dc in next dc, skip next 2 dc, sc in next dc) 7 times, leave remaining sts unworked: 7 Shells.

Row 6: Ch 3, turn; 2 dc in first sc, skip next 2 dc, sc in next dc, (5 dc in next sc, skip next 2 dc, sc in next dc) across to last sc, 3 dc in last sc.

Row 7: Ch 1, turn; sc in first dc, (5 dc in next sc, skip next 2 dc, sc in next dc) across.

Rows 8-11: Repeat Rows 6 and 7 twice.

Neck Edge: Ch 4, working in end of rows, skip first row, (dc in end of next row, ch 1, skip next row) 3 times, (skip next dc, dc in next dc, ch 1) 3 times, dc in end of next row, (ch 1, skip next row, dc in next row) 3 times; finish off:
10 ch-1 sps.

Weave ribbon through ch-1 sps on Neck Edge.

Weave in all yarn ends.

See the September 2004 newsletter for a shorter dress & a jacket pattern in this set designed by Terry Kimbrough.

CROCHET PATTERNS



GOWN

Ch 27 loosely.

Row 1 (Right side): 2 Dc in fourth ch from hook, (dc in next ch, 2 dc in next ch) across to last ch, dc in last ch: 37 dc.

Row 2: Ch 1, turn; sc in each sc across.

Row 3: Ch 3 (counts as first dc, now and throughout), 2 dc in next sc, (dc in next sc, 2 dc in next sc) across, dc in last sc: 55 dc.

Row 4: Ch 1, turn; sc in each sc across.

Rows 5 and 6: Repeat Rows 3 and 4: 82 sc.

Row 7: Ch 1, turn; skip first sc, sc in next 12 sc, skip next 16 sc (for Armhole), sc in next 25 sc, skip next 16 sc (for Armhole), sc in last 12 sc: 49 sc.

Row 8: Ch 4, turn; dc in first sc, (ch 1, skip next sc, dc in next sc) across, ch 1, dc again in last sc: 26 ch-1 sps.

Row 9: Ch 1, turn; sc in first dc, 5 dc in next dc (Shell made), (sc in next dc, 5 dc in next dc) across, sc in third ch of turning ch: 13 Shells.

Row 10: Ch 3, turn; 2 dc in first sc, skip

next 2 dc, sc in next dc, work (5 dc in next sc, skip next 2 dc, sc in next dc) across to last sc, 3 dc in last sc.

Row 11: Ch 1, turn; sc in first dc, 5 dc in next sc, skip next 2 dc, (sc in next dc, 5 dc in next sc, skip next 2 dc) across to turning ch, sc in top of turning ch.

Repeat Rows 10 and 11 for pattern until Gown measures approximately 14" from beginning or until desired length, ending by working a right side row; do NOT finish off.

Edging: Working in end of rows along back, sc evenly across to neck edge, sc in free loops of each ch across neck, working in end of rows along other edge of back, sc evenly across to last row, slip st in last row; finish off.

Sleeve

Rnd 1: With right side of Gown facing, join yarn with sc in underarm, skip next 2 sc, 5 dc in next sc, (skip next sc, sc in next sc, skip next sc, 5 dc in next sc) 3 times; join with slip st to first sc:

4 Shells.

Rnd 2: Ch 3, turn; 2 dc in same st as joining, skip next 2 dc, sc in next dc, (5 dc in next sc, skip next 2 dc, sc in next dc) around, 2 dc in same st as joining; join with slip st to first dc.

Rnd 3: Ch 1, turn; sc in same st as joining, 5 dc in next sc, skip next 2 dc, (sc in next dc, 5 dc in next sc, skip next 2 dc) around; join with slip st to first sc.

Repeat Rnds 2 and 3, 4 times or until Sleeve measures desired length, ending by working a right side row; finish off.

Repeat for second sleeve.

Weave ribbon through spaces at waist and tie in back (see Note on page 1).

Add ribbon or snap or Velcro closure at neck edge.

Weave in all yarn ends.

Note: You can sew the back seam part of the way, but if you are using this as a burial gown, most hospitals prefer that the back is left open.

BOOTIES

Ch 9 loosely.

Rnd 1: 6 Dc in fourth ch from hook, dc in next 4 chs, 7 7 double crochet in last ch, working in free loops of beginning ch, dc in next 4 chs; join with slip st to top of beginning ch: 22 sts.

Rnd 2: Ch 3, dc in same st as joining, 2 dc in next 6 dc, dc in next 4 dc, 2 dc in next 7 dc, dc in last 4 dc; join with slip st to first dc: 36 dc.

Note: Work dc decrease as follows: (YO, insert hook in next st and pull up a loop, YO and draw through 2 loops on hook) twice, YO and draw through all 3 loops on hook (dc decrease made).

Rnd 3: Ch 1, sc in same st and in next 17 dc, work dc decrease 7 times, sc in each sc around; join with slip st to first sc: 29 sts.

Rnd 4: Ch 1, sc in same st and in next 16 sc, work dc decrease 5 times, sc in last 2 sc; join with slip st to first sc: 24 sts.

Rnd 5: Ch 4, skip first 2 sts, (dc in next st, ch 1, skip next st) around; join with slip st in third ch of beginning ch: 12 ch-1 sps.

Rnd 6: Ch 1, sc in same st as joining, 5 dc in next dc, work (sc in next dc, 5 dc in next dc) around; join with slip st to first sc, finish off.

Repeat for second Bootie.

Weave ribbon through ch-1 sps.

Weave in all yarn ends.



BLANKET

Note: Make a blanket any size you like by making a chain (loosely) a few inches longer than the desired width. Figure the exact starting chain, by making the chain a multiple of 6+2.

Row 1: Single crochet across and turn.

Row 2 (right side): Sc in second ch from hook, (skip next 2 chs, 5 dc in next ch, skip next 2 chs, sc in next ch) across.

Row 3: Ch 3, turn; 2 dc in first sc, skip next 2 dc, sc in next dc, (5 dc in next sc, skip next 2 dc, sc in next dc) across to last sc, 3 dc in last sc.

Row 4: Ch1, turn; sc in first dc, (5 dc in next sc, skip next 2 dc, sc in next dc) across.

Repeat **Rows 3 and 4** for pattern until blanket is desired length, ending by working a right side row.

Gown, hat, & booties with a fleece blanket (w/crochet edge)



CROCHET PATTERNS

BABY BURIAL SHROUD

Here are two lovely patterns with photos to inspire you to make these for the NICU in your area. Decorate with lace, bows, ribbon roses, buttons, & adjust the size (length & width) to the needs of the NICU. Adjust the number of stitches and number of rows to make other lengths/widths. Make a few samples in different sizes and ask the hospital for feedback. It is important to make these shrouds EASY to get on the baby.



Here is a picture of the baby shroud (bunting) with a hat made using the Afghan Stitch. For instructions for the Afghan Stitch, go to YouTube for a "how to."

AFGHAN STITCH BABY SHROUD (10" by 11 1/2")

Size K afghan stitch needle 4-ply yarn (Caron Simply Soft)

Chain 40

Use the afghan/Tunisian stitch for the whole 10" by 11 1/2" piece.

Fold in half & sew up the bottom about half way up the sides.

Turn right side out and that's it.

Matching Hat

Chain 25

Use the afghan/Tunisian stitch for 12 rows

Whip stitch the sides and close the top

Turn right side out and it's done.

Add buttons, ribbon roses, bows, lace, or other trims to the shroud & hat.
Barbara DeRocher



CROCHET BURIAL SHROUD

Materials: 4-ply worsted yarn

Size H or I crochet hook

Crochet a chain approximately 11 1/2" long, or as long as this newsletter is tall. My chain was actually 38", but I tend to crochet tightly.

Double crochet in 4th chain from hook, & in each chain across. * Ch 3 & turn. Double crochet BLO in each double crochet stitch across. Repeat from * until you have a rectangular piece approximately 8 1/2" x 11"; about 15 rows. To check: Close your newsletter. Your crocheted piece should be about the same size as the newsletter. Trim yarn & weave in ends.

Finishing: Fold the 2 short sides to the center to form a piece about 5 1/2" x 8 1/2". Stitch across the bottom to form a pouch. Stitch the opening from the bottom up— about 2 1/2". Trim yarn and weave in ends.

Sew buttons on so that the "chain 3" on the opposite side can be looped over the button. Top button placement is 2" from the top so the top can fold into a collar. Bottom button is between top button and bottom of opening.

Embellish with ribbon & trim as desired. Including a small baby hat adds a nice touch.

I hope my instructions work for you! Marie Geisinger

GENERAL INFORMATION FOR SEWING PROJECTS

- Use SOFT fabrics such as broadcloth, fleece, cotton flannel, cotton knit, or terry cloth.
- It is recommended that you wash fabrics—even those new from the retail store. Stores are dusty and some fabrics have harsh finishes. Wash any completed projects that are soiled or dusty. Do NOT use fabric softeners or fragrant rinses in the wash water.
- Edges on kimonos, receiving blankets, & diaper shirts can be serged, bound, zig-zagged, or finished with decorative/overcast stitches.
- Do not attach buttons (or anything that an infant might swallow) on kimonos, toys, diaper shirts, etc. VERY SECURELY attach ribbons or bows.
- Fabric paint (lead free) is a suitable alternative to embroidery or felt eyes, etc. on finger puppets or toys.
- Keep your projects FAR AWAY from smokers and pets.
- Package completed items in plastic bags to keep clean. (Several items may be packaged together. Do not add sachet or moth balls to your packages.)
- Be very careful to remove all straight pins from your projects.**

Bibs

- ☞ Using graph paper, copy patterns given here, enlarging each square to 1". Cut out.
- ☞ Sew right sides together leaving area open to turn. (Alternative: Sew wrong sides together and bind [bias binding] or serge edges.)
- ☞ For large bib, sew snap where indicated. For small bib, finish neck edge with bias tape, extending past edge to form ties.



BIBS

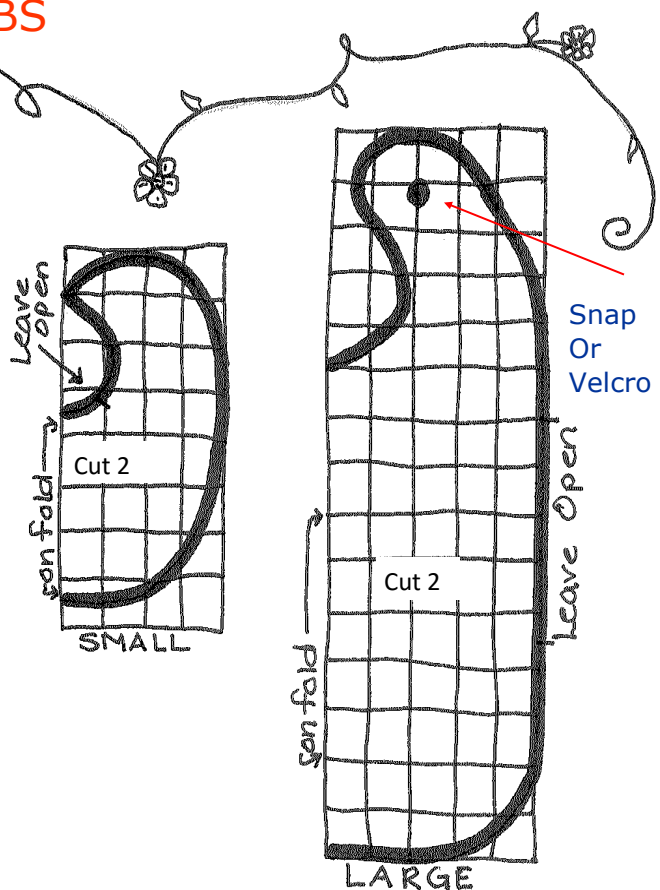

Each square = one inch

It is OK to vary the shapes of bibs.

SEWING PATTERNS

BLANKETS & SIMPLE QUILTS

Most hospitals welcome blankets & quilts.
Sizes: 30" x 30" 36" x 36" or 36" x 42"

Flannel blankets may be hemmed, bound, or serged in matching or contrasting color. A crochet edging is a lovely finish, too.

See the December 2010 newsletter (p. 18) for information on preparing fleece or flannel for a crochet edge with a perforating rotary blade.

Quilt tops may be pieced or one piece (a bright color or cheerful children's print).



Tie, machine stitch, or hand stitch the layers together. Remember that quilts will be machine washed. Tie or stitch frequently so the batting does not bunch up when washed.



SIMPLE 30" x 30" QUILT

MATERIALS:

- 30" x 30" fabric for the quilt top*
- 34" x 34" fabric for the quilt back/bottom**
- 30" x 30" batting ***

DIRECTONS:

Position the three layers on a flat surface.

1st layer: Quilt backing (right side facing DOWN)

2nd layer: Center the batting in the middle of the quilt back.

3rd layer: Center the quilt top (right side facing UP) on top of the batting.

You will have 2" of quilt bottom showing on all four sides. Fold that 2" extension in half & then up on top of the quilt top—to form a border/hem. Pin in place. Miter the corners, if you wish. Machine sew that border/hem in place through all of the layers.**** Then, tie the quilt layers together at approximately 5" intervals*****

* A one-piece quilt top of a cute print is fine! If you use an adorable or colorful fabric for the top, you do not have to work hours to create a patchwork or appliqué masterpiece.

** Some hospitals request quilts with dark colors on the bottom so that they can be used as covers over the isolettes. Those covers provide tranquil darkness to allow infants to sleep.

*** Consider using 100% polyester felt for the batting. Felt is easier to handle than quilt batting. It provides good insulation, does not bunch up, and is machine washable.

**** Consider machine stitching the border/hem along the folded edge (1" from the edge) & then around the very edge of the quilt (1/8" from the edge) in order to keep the batting flat and in position. Use straight, zigzag, or triple step zig-zag stitch. (See diagram & blue arrows above)

***** Use soft yarn, pearl cotton, or crochet cotton to tie the layers; use a contrasting color to make the quilt more colorful.

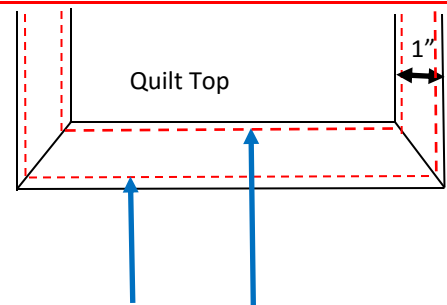

**Stitch
Before
Stuffing**



Enlarge this bunny pattern 110% for a bunny that is easier to stuff. The larger size is an adorable toy!

FIBERFILL BUNNY

1. Cut two (cotton flannel, broadcloth, chintz or other soft fabric).
2. Place right sides together and stitch with 1/4" seam allowance—leaving the bottom open 3" to 4" for ease of stuffing.
3. Clip all curved seam allowances.
4. Turn bunny to right side.
5. Stitch dividing line between rabbit ears.
6. Stuff with fiberfill pushing fiberfill into the upper ears with a pencil or chopstick.
7. Close the bottom opening with a slip stitch.
8. Embroider or textile paint the face.
9. Tie a ribbon snugly around bunny's neck with knot & bow. Hand stitch the ribbon to the back of neck so that the ribbon cannot be removed and ingested.



Leave open to Fill

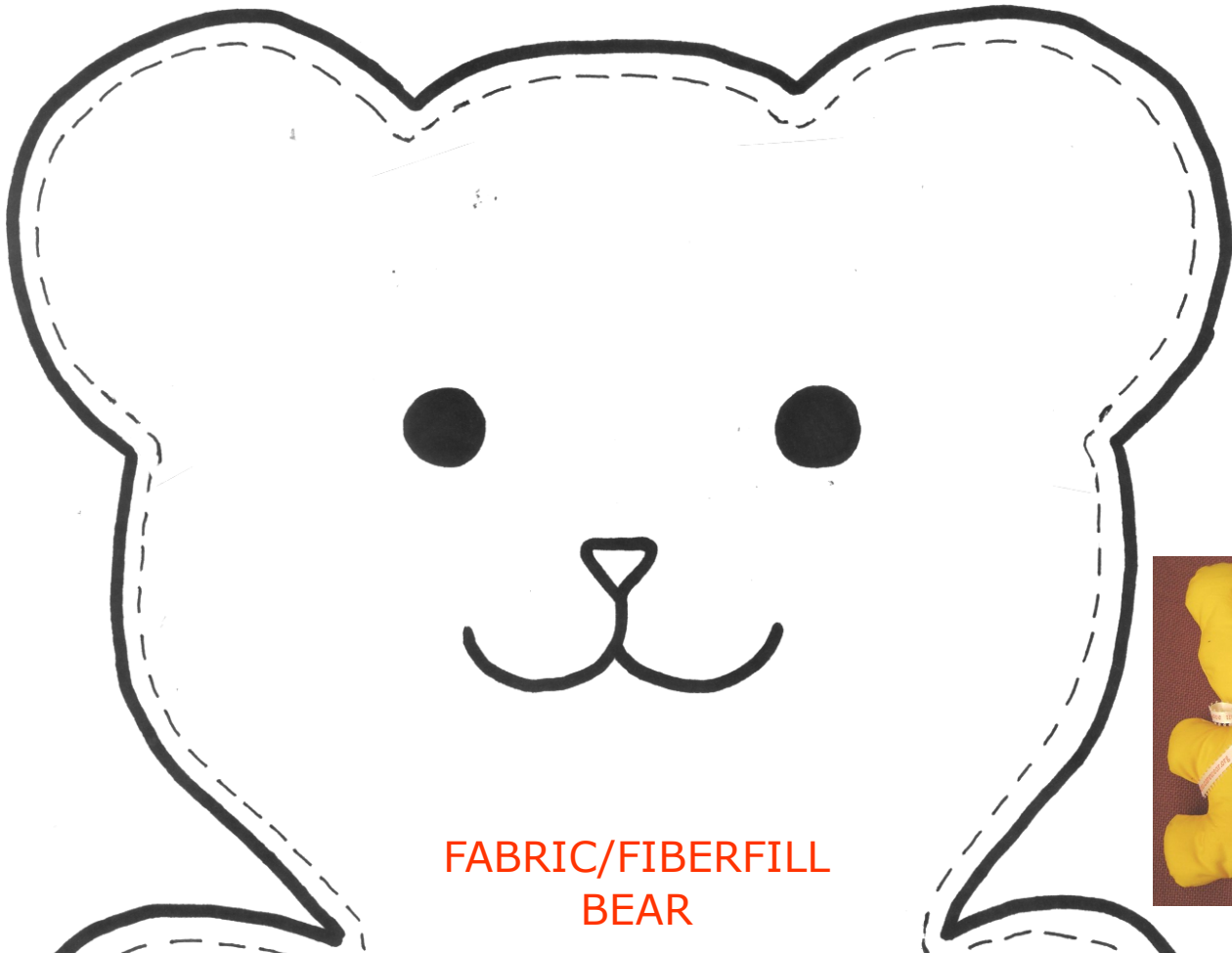

FABRIC/FIBERFILL BEAR



This bear pattern was reduced in size to fit on the page. If you wish to have the original size, enlarge 115% on a photocopier. (It is OK to make the bear this size or even smaller.)



1. Cut two (cotton flannel, broadcloth, or other soft and washable fabric.)
2. Place right sides together and stitch the seam with 1/4" seam allowances. Stitch in curves (not "V" shapes) around the outline of this bear.
3. Clip all curved seam allowances every 1/2".
4. Turn bear to right side and stuff with fiberfill.
5. Slip stitch the opening closed.
6. Embroider or fabric paint the face.
7. Tie a ribbon around the neck with a knot, then a bow. Hand stitch the ribbon in place at the back neck so that the ribbon cannot be removed & ingested.

1/4"
seam

allowance

Leave open (3"-4") to stuff

SEWING PATTERNS

WHEELCHAIR/WALKER CADDIES

- Maybe you or your group would like to sew wheelchair or walker caddies for an area hospital, nursing home, or rehabilitation center.
- Use sturdy fabrics: denim, drapery or light weight upholstery fabrics, etc.
- Consider making one pocket more secure — with a zipper or Velcro fastening. Another variation is to have the ties with Velcro.

The walker caddie pattern shown at right is excellent for wheelchairs. A lengthened version (cut 21" long instead of 15") holds more "stuff" for patients using walkers. The pocket is 9" deep instead of 6" deep.

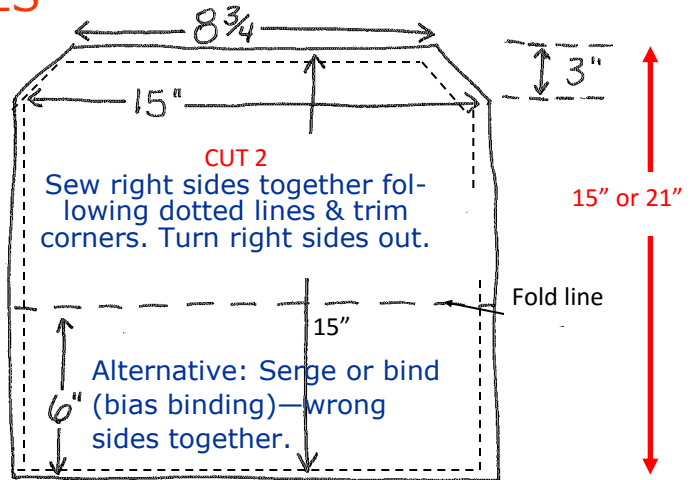

2 - 26" Twill Tape Ties (fold in half)

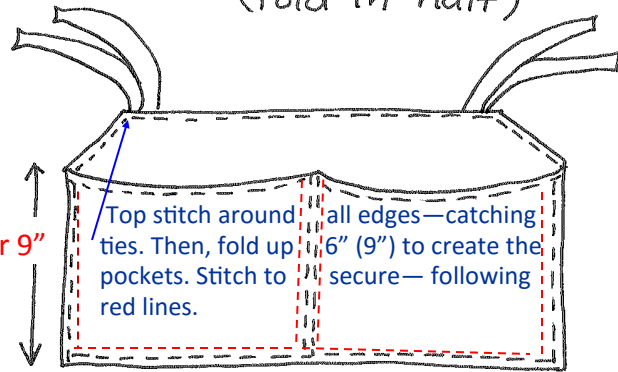

6" or 9"

Saddle-Bag Walker Caddie



Here is the Saddle-Bag walker caddie. Illustrations and directions are in the March 2013 Care Wear Volunteers newsletter—page 6—(on our website: www.carewear.org).

ADD seam allowances to measurements for fabrics that ravel.

- Cut 2: 13" x 51 1/2"
- Fabrics that ravel: Sew right sides together & turn. Non-raveling fabrics: Sew wrong sides together all around.
- Sew 3" Velcro strips on reverse side.
- Fold up pockets (11 1/2") on 2 ends & stitch in place.

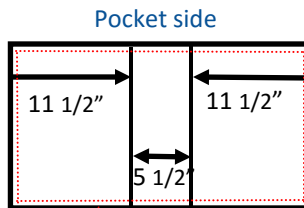

Reverse side



SEWING PATTERNS

"SCRAPPY PEOPLE PILLOW" TOY

By: Diana Olson and Judy Govotsos
For: Care Wear Volunteers
January 2010

DIRECTIONS:

The measurements of the Scrappy Pillow People are approximates. If they are a little bigger or smaller, that is fine. The shape can vary also to fit the scrap piece of fabric. Arms and legs can be made from different fabrics or grosgrain ribbon. I used the serger for most of the sewing, but you can use a sewing machine just as easily.

Cut 2 body, 2 legs, 2 arms.

Fold and serge (or machine stitch) the fabric legs and arms lengthwise.

Pin the arms and legs in position between the body parts right sides together. Make sure the other ends of the arms & legs are not caught in the seams. Start sewing along the bottom (about 1/2" past the leg), up one side, across the top, down the other side, and across the bottom (about 1/2" past the leg). Leave an opening approx. 3" to 4" wide for easy stuffing. Back stitch when you start and end.

Turn body right side out. Stuff lightly. Hand sew bottom shut.

Paint eyes & mouth on the front of the top body half.

Tie a knot on the ends of the legs and arms.

Pattern on next page

These are really adorable toys! Everyone enjoys stuffing them (no little ears to stuff!!!) and the finished results are very cute! Children love to swing these toys around by the arms/legs!

Thanks to Judy and Diana for their creative inspiration.

What a wonderful project to use leftover scraps of all sizes and colors!!!! Cut out in various sizes and consider using grosgrain ribbon or crochet chains for arms & legs.



58



SEWING PATTERNS

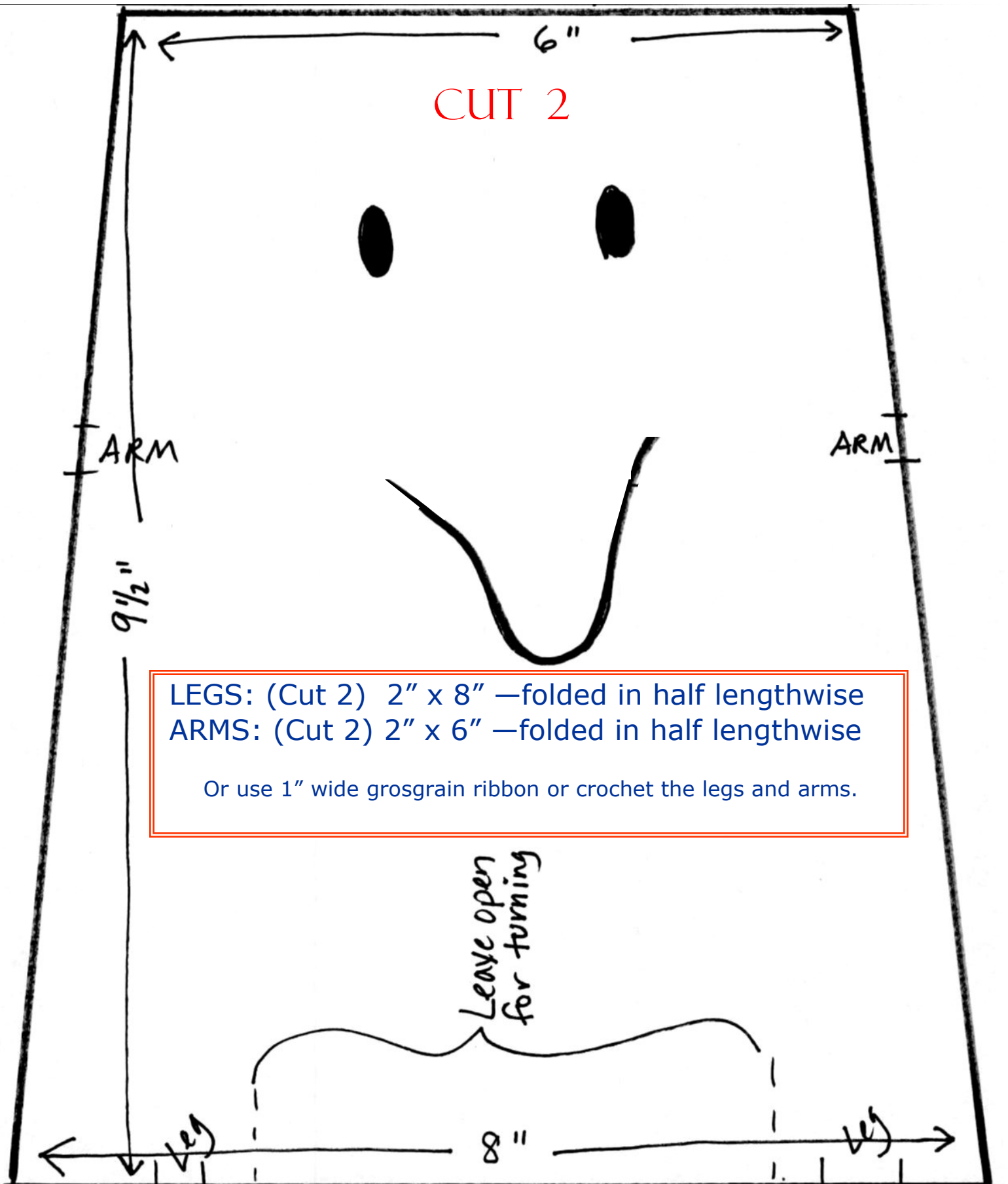

SEWING PATTERNS

MEDICAL-SURGICAL DOLL (BLANK CLOTH DOLL)

This pattern was provided by Johns Hopkins University Hospital (Child Life Dept). These dolls are requested by MANY hospitals—for surgery preparation, grief counseling, & abuse investigations.

Background: The following information is extracted from an article entitled "The Use of Stuffed, Body-Outline Dolls with Hospitalized Children & Adolescents," by Laura Gaynard, Joy Goldberger, and Lesley Laidley.

The process of creating and personalizing a blank, stuffed, body-shaped doll can provide children with a pleasurable and expressive activity which can be used by the hospital staff in many ways. The children decorate the dolls with non-toxic permanent markers. The dolls become a part of the treatment process & the children take them home with them when they are discharged.

The dolls can be used to help develop a rapport with the children and to help them relax in a hospital environment. The staff may use the dolls to help assess the child's perceptions and feelings; talking about the doll is a non-threatening way to explore the child's own concerns. Another use of the dolls is to help the children prepare for and cope with their treatment process. The doll can be used to show such things as where an injection will be given or what posture/body position is desired. And, of course, the dolls can be a wonderful source of comfort for the children.

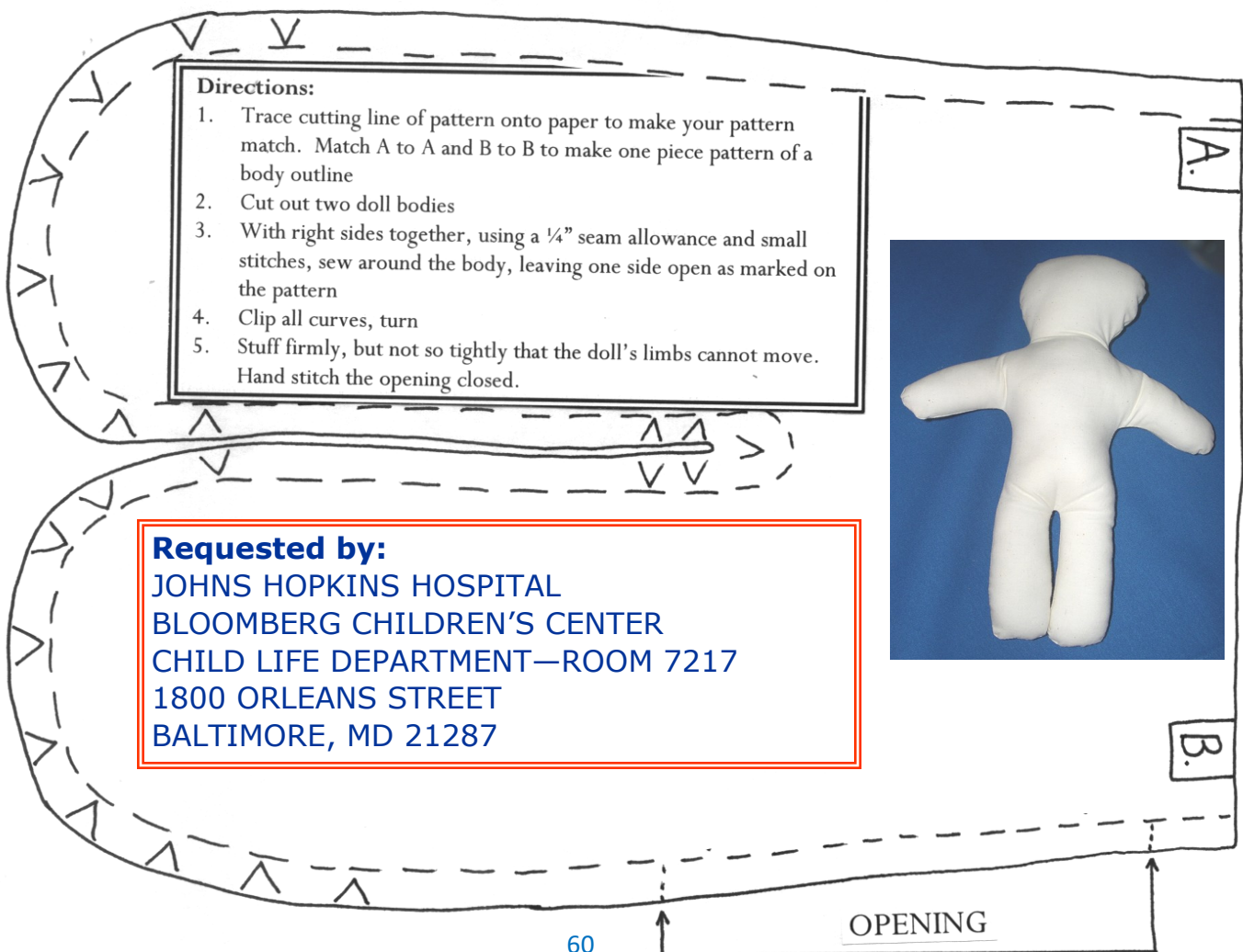

SEWING PATTERNS

Medical-surgical dolls ready
to stuff

PLEASE do not add any
decorations, eyes,
faces, ribbons,
appliqués, etc. to
these dolls.



Reconnect the two halves of this pattern piece before cutting fabric.

SUPPLIES

- 12" x 17" piece of tracing paper (for your pattern) and a pencil
- 1/3 yard of 35" or 45" wide woven cotton or cotton blend in skin tone colors

(Johns Hopkins requests a variety of beige, tan, olive, & brown tones. Tea dyeing or using brown and tan shades of Rit-type dye is fine. Choose even (not mottled) colors that look like healthy skin tones. The color should be light enough that permanent fabric markers will show on it.)

- Sewing thread to match fabric
- Polyester Fiberfill for stuffing (Firmly stuff to enable writing on the surface.)



Smocks/hospital gowns to dress each doll are requested. Go to the Care Wear Volunteers website:

<http://www.carewear.org>

See Care Wear Newsletters for sewing patterns for hospital gowns to fit the medical doll:

March 2002 (page 21)

June 2004 (page 12)

March 2017 (pages 20-21)

Knit or crochet gowns are welcomed, too.

SEWING PATTERNS

FLEECE HAT

Fabric: Knit fabric with good stretch

Directions:

Step #1: Cut out hat

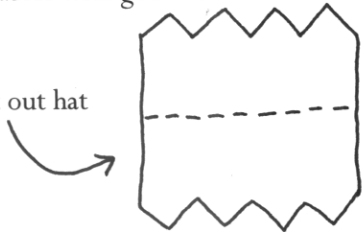

Step #2: Fold in half vertically (right sides together)
Sew vertical seam to create a tube

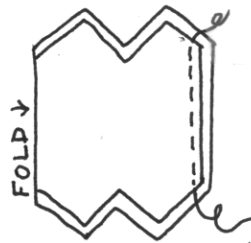

Step #3: Fold hat in half along horizontal fold line (see illustration in Step #1)
Seam allowance is inside
Match seam (mismatched seam will cause twisting)

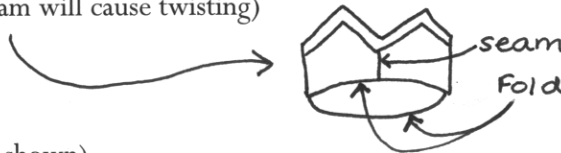

Step #4: Reposition seam to side (as shown)
Match four peaks and sew (serge) slanted seam by side seam of hat

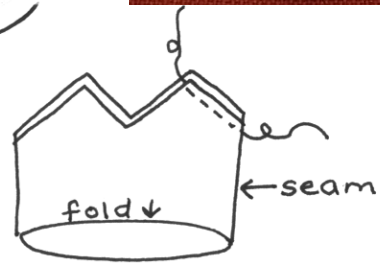

Step #5: Sew the opposite seam (see diagram)

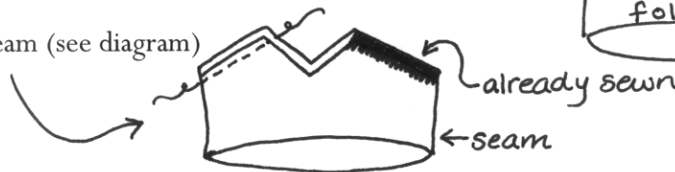

Step #6: Refold hat so two sewn seams touch at the peak
Sew remaining two slanted seams (in one line) going over the peak

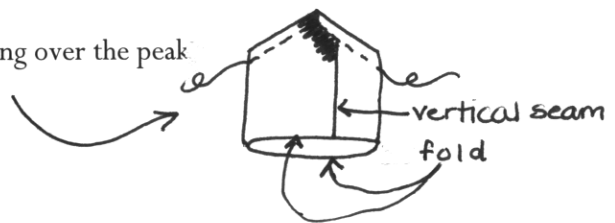

Hat is done! Fold up a "cuff"!
This hat can be a chemo hat too!

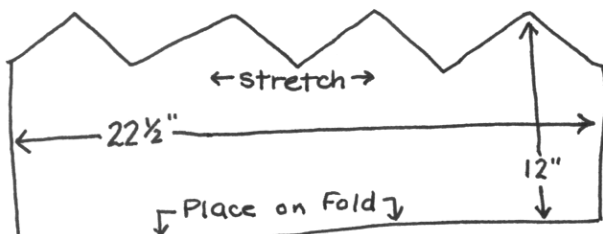

Adult Size 22½" x 12"

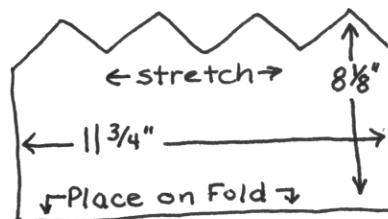

Newborn/Full-Term 8⅛" x 11¾"

Thanks to Donna S. and Carolyn V. for the patterns, samples, and the directions!

FLEECE HAT PATTERNS

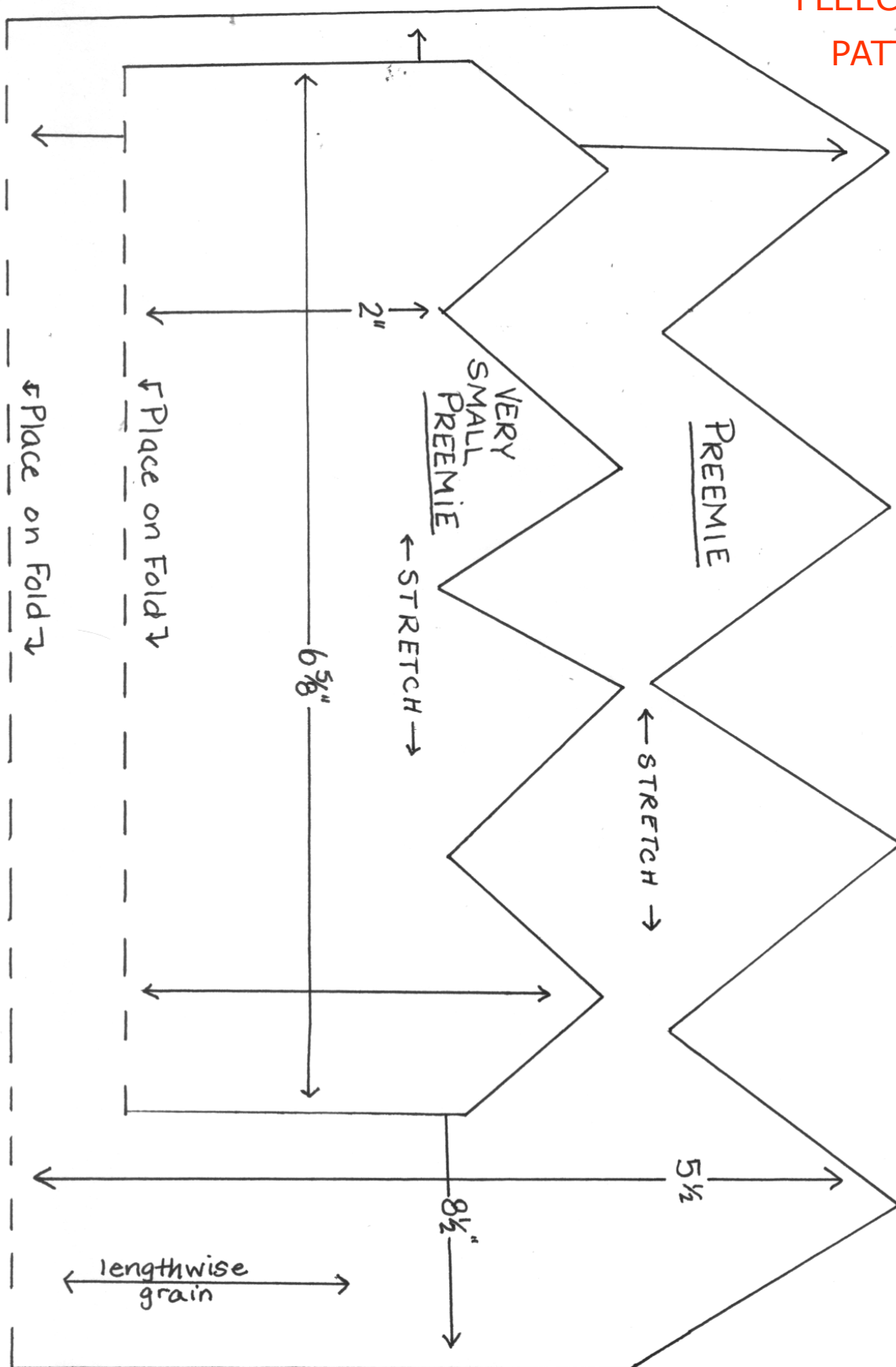

BURIAL WRAP FOR PREEMIES & MICRO-PREEMIES

Burial Wrap for Preemies & Micro-Preemies

(from Lois Byford, Care Wear Volunteers of Wisconsin and Newborns in Need Message Center)

Fabrics: Outer wrap—satin, broadcloth, brocade, cotton (in white, ivory, pastels, or appropriate prints)
Lining wrap—flannel, velveteen, or other soft fabric

Directions:

1. Cut two outer wrap pieces and two lining wrap pieces.
2. Outer wrap: Take your two outer wrap pieces, put right sides together, and sew a 1/4" seam along seam A. (++++++)
3. Lining wrap: Take your two lining wrap pieces, put right sides together, and sew a 1/4" seam along seam A. (++++++)
4. Clip and press those seams.
5. Place your outer wrap (now two sections with a centered seam) and your lining wrap (now two sections with a centered seam) together with right sides together. Sew a 1/4" seam along seam B (xxxxxx).
6. Clip and press seams.
7. Turn up (toward the wrong sides) 1/4" across the bottom, pin, & press.
8. Position two pieces of Velcro on either side of the front edges as pictured. Both hook sides on one edge. Both soft fuzzy sides on the 2nd edge. Pin in place.
9. Topstitch around the entire burial wrap—through the pieces of Velcro.
10. For a girl, decorate with ribbon roses or bows. For a boy, decorate with a bow tie or other boy-appique. Position on front—as indicated in the diagram.

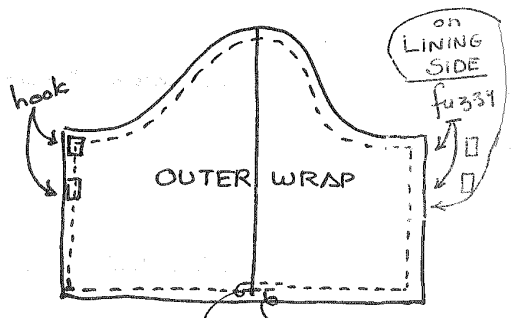
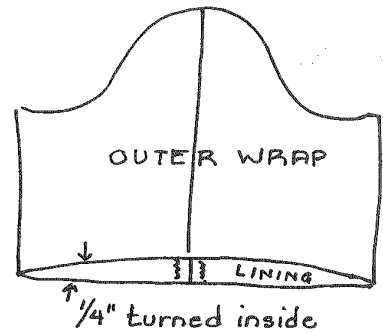
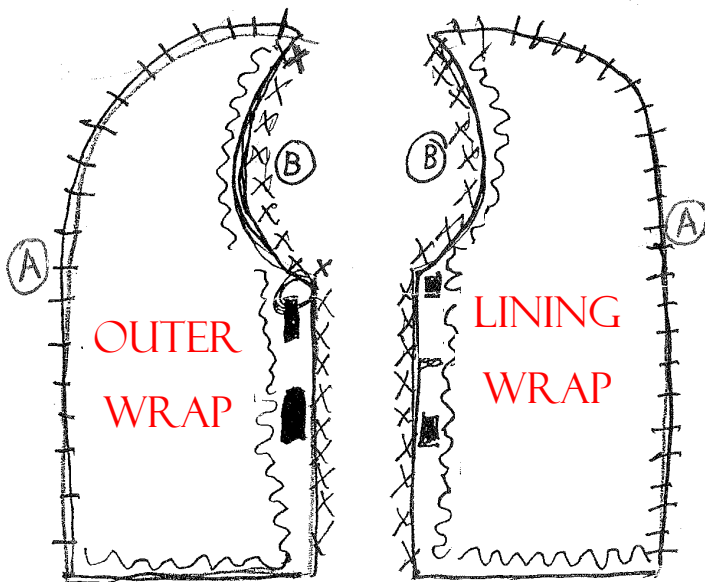
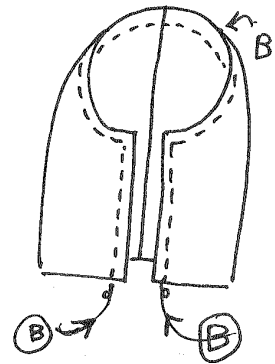
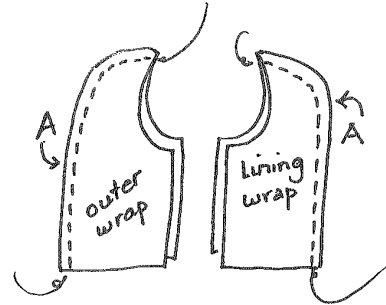

Attach a bow-tie, bow, or ribbon rose

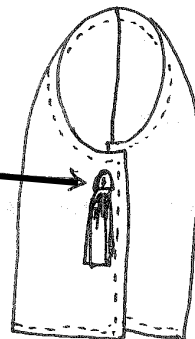

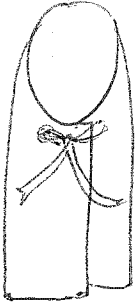

BURIAL WRAP
PATTERN

Carewear Volunteers of Wisc.
Lois Byford

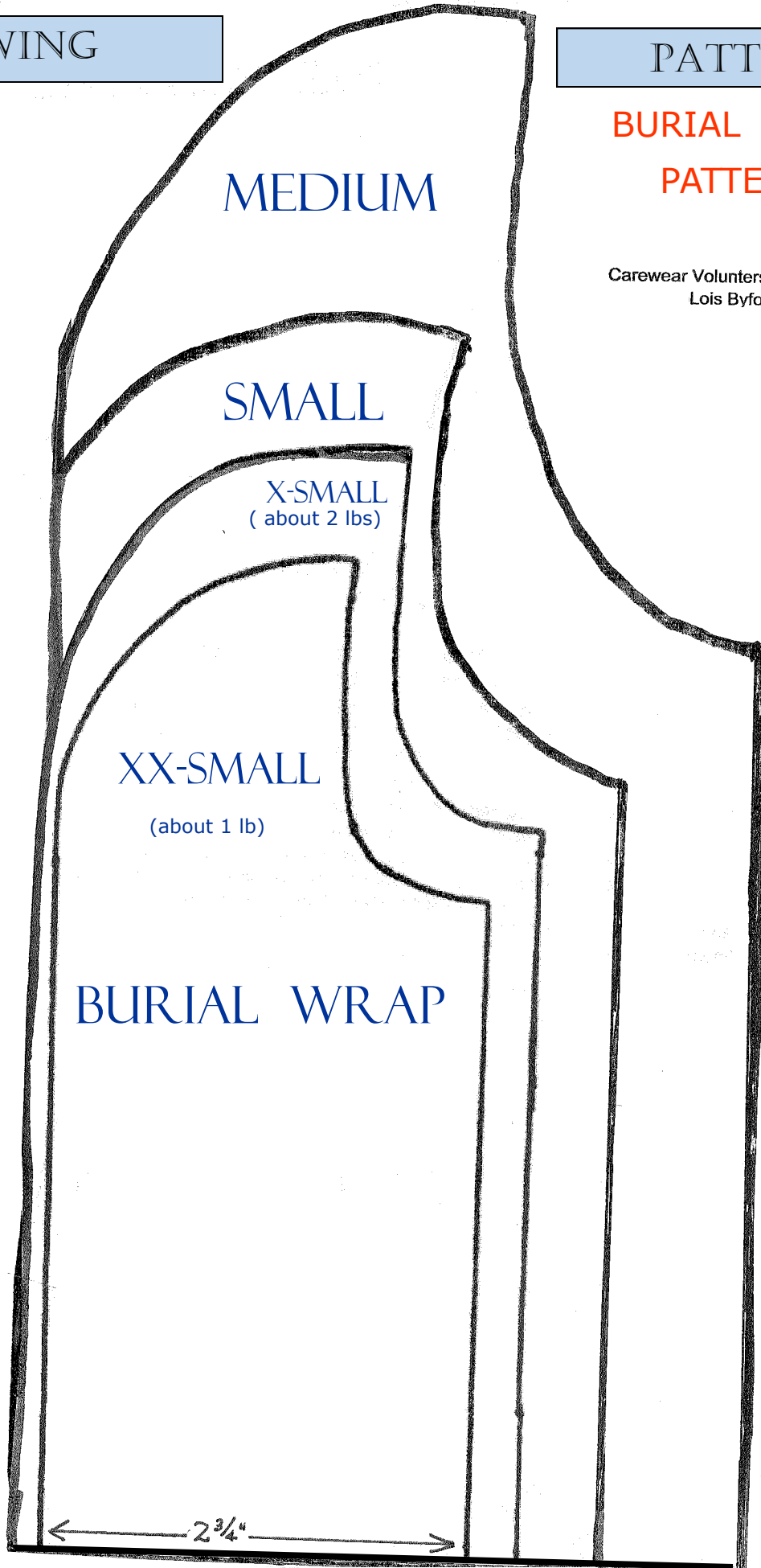

BURIAL GOWN PATTERN

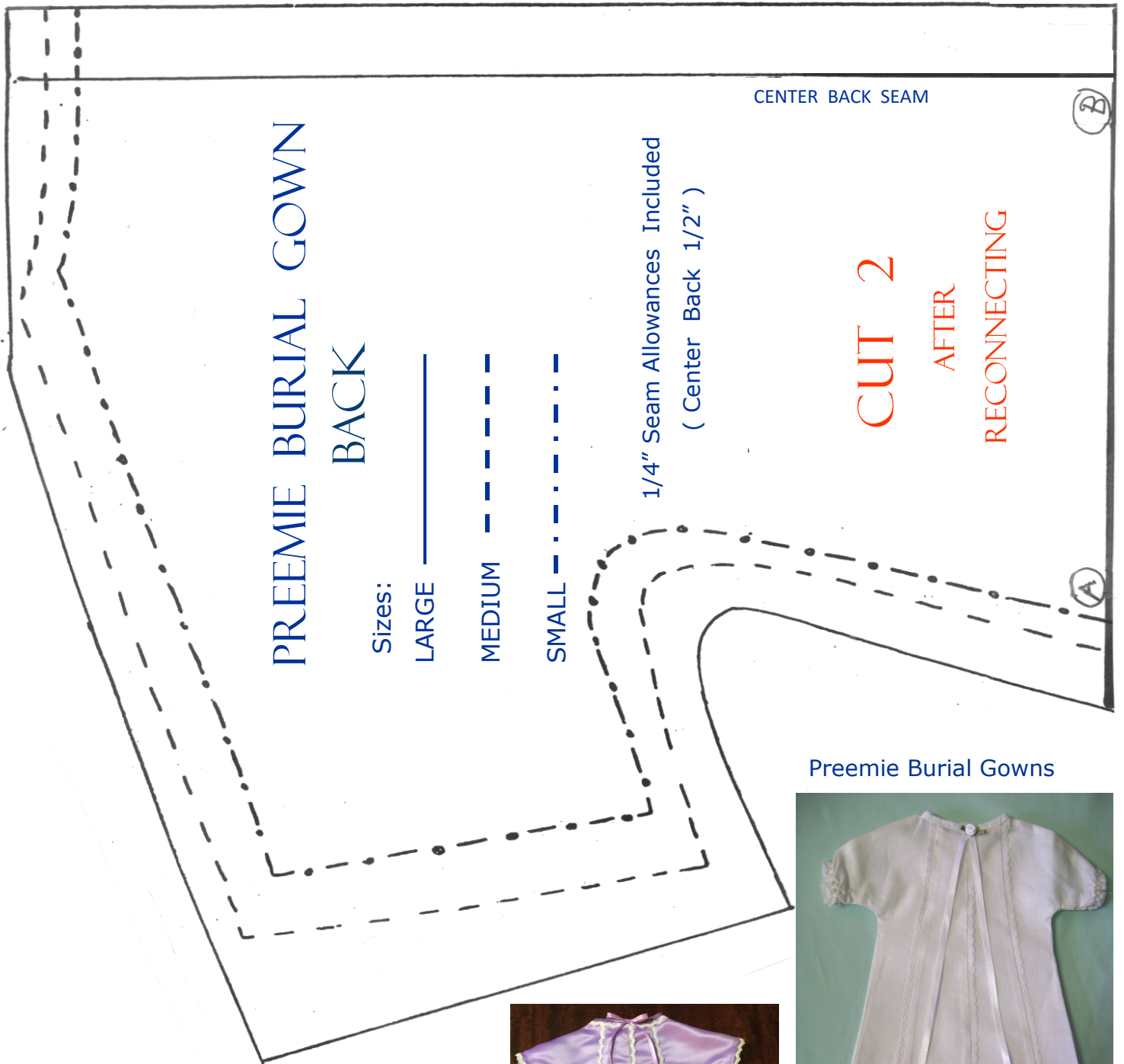

Premie Burial Gowns



CENTER BACK SEAM

This is the lower half of the **BACK** of the Premie Burial gown.

PLEASE RECONNECT PATTERN PIECE before cutting fabric.

Trace or photocopy both halves of the gown back and join A & B—bringing the solid lines together.

DIRECTIONS:

1. Pin 3/8" lace along center front seam—with lace extending out from the seam.
2. Sew the two center panels together (the center front seam).
3. Pin lace to the notched seam of the two side front panels.
4. Sew side front panel to the center front panels along notched seam.
5. Press center back seam allowances to the wrong side. Back seam is left open. (Seam finish optional)
6. Sew underarm seam—attaching gown front to gown back.
7. Turn under 1/4" at bottom of sleeve. Attach lace, then attach elastic (4" for small, 4.5" for medium, and 5" for size large) **OR** make a casing for a drawstring ribbon **OR** leave the bottom edge just hemmed & lace trimmed—for ease dressing the infant.
8. Sew shoulder seam.
9. Optional: Attach slightly gathered lace around the neckline with lace extending down toward gown.
10. Cut a 20" length of double fold bias tape & attach around the neckline with equal length ends extending as ties at center back.
11. Hem bottom edge. Attach lace (optional).

Burial garment trimmings



SEWING PATTERNS

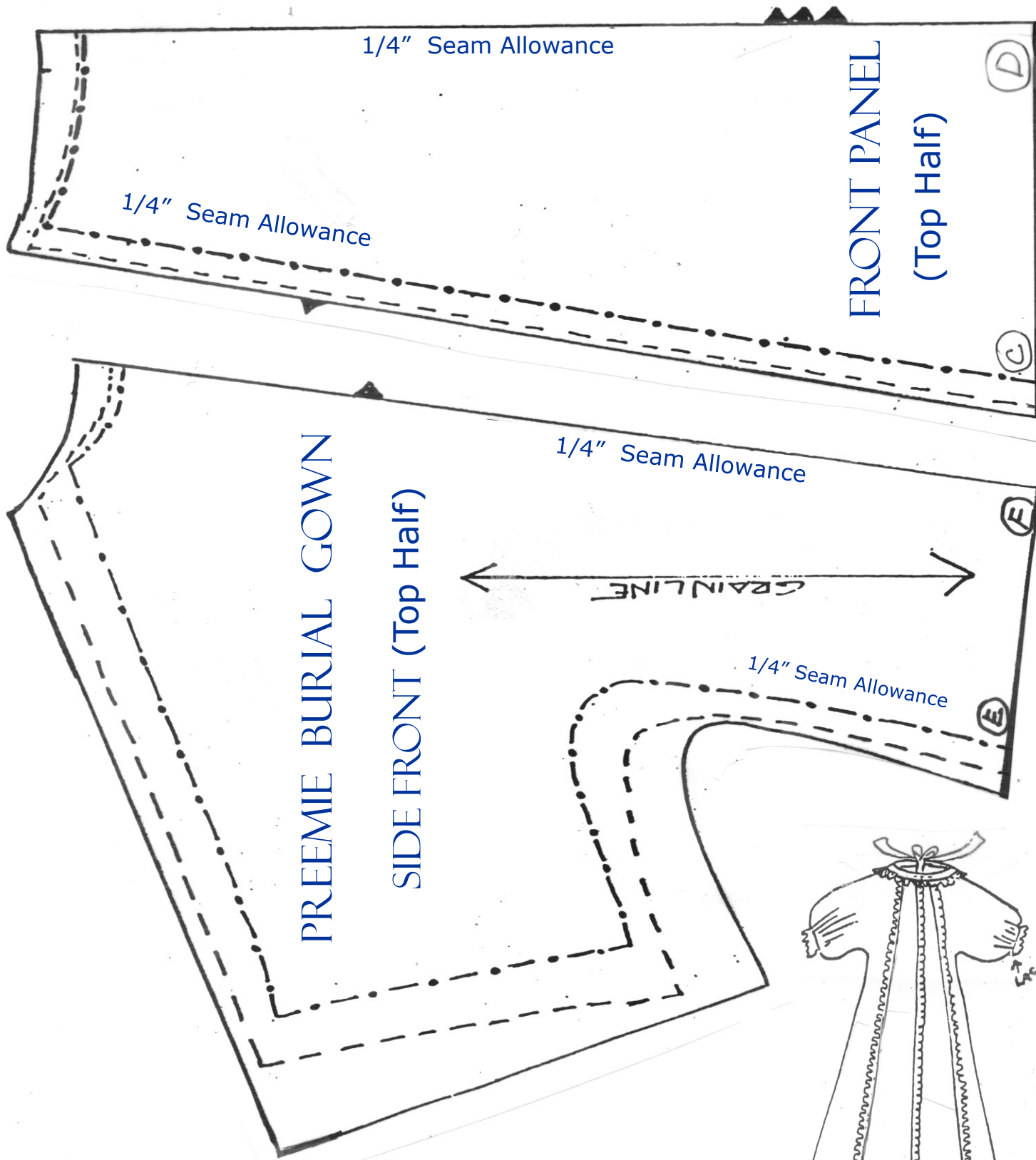

RECONNECT PATTERN PIECES BEFORE CUTTING FABRIC

SEWING PATTERNS

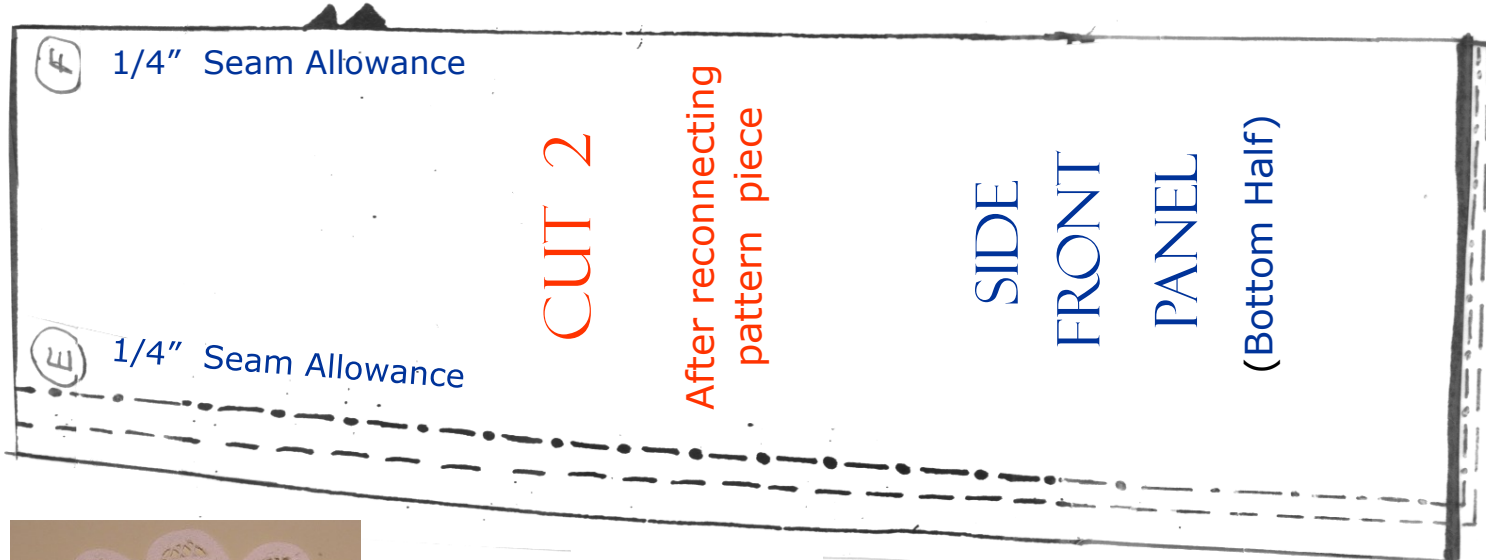
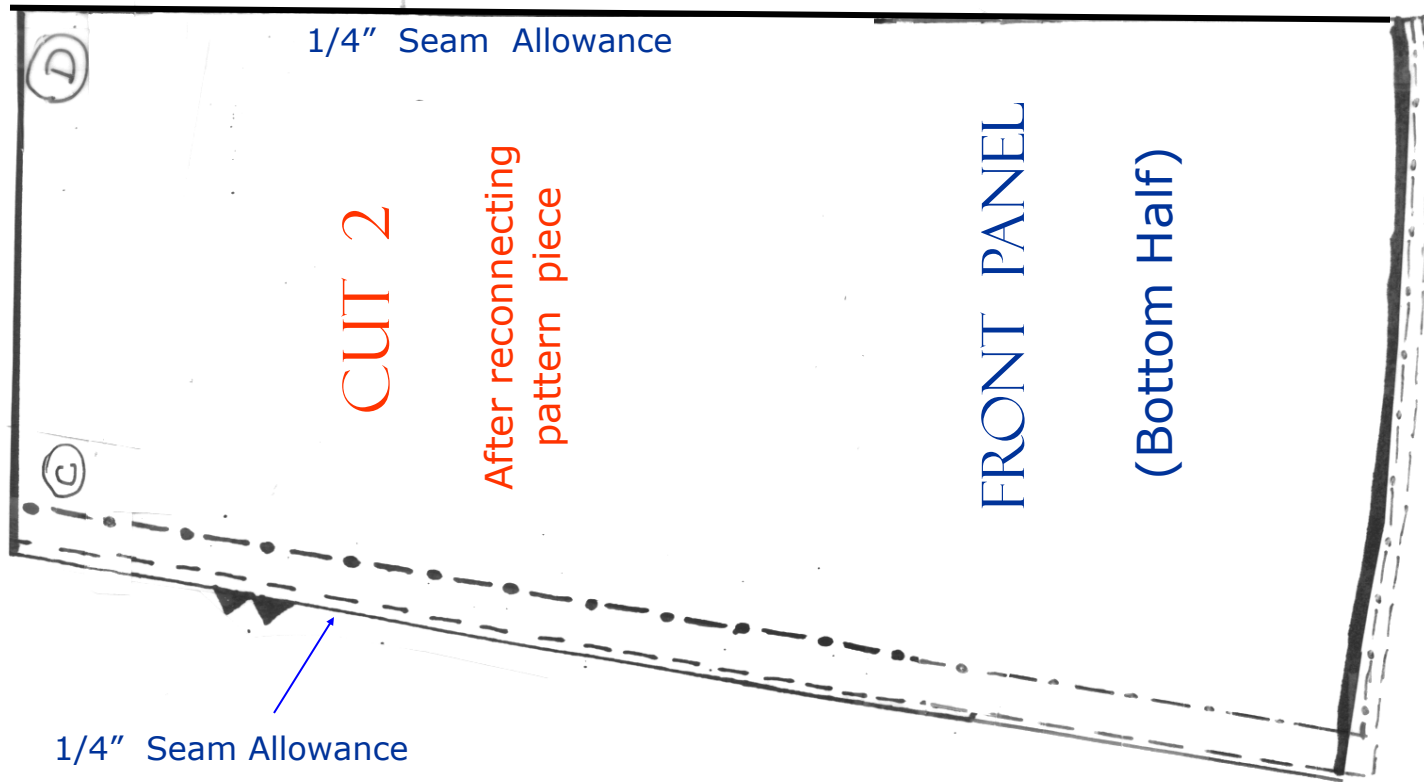

Angel appliqués, satin ribbon roses and narrow lace and ribbon are lovely decorations



SEWING PATTERNS

SUPPLIES: COTTON OR FLAME RETARDANT FLANNEL, COTTON KNITS, ETC
VELCRO (TM) OR OTHER HOOK/FASTENER TAPE
THREAD
DOUBLE FOLD BIAS TAPE OR SERGER THREAD

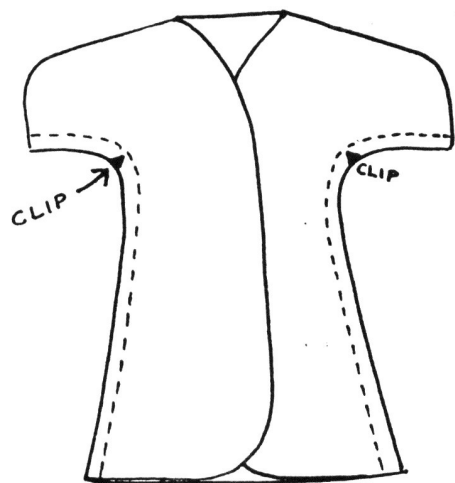

INSTRUCTIONS:

1. TRACE OFF PATTERNS FOR FRONT & BACK FOR EACH SIZE.
2. PIN PATTERN TO FABRIC AND CUT OUT
NOTE: KIMONO BACK IS CUT ON A FOLD
KIMONO FRONT IS CUT TWICE
3. WITH RIGHT SIDES TOGETHER, SEW A 1/4" SEAM ALONG THE SIDE/UNDERARM SEAM
4. SEAM FINISH THAT SEAM BY PINKING, ZIG-ZAG, OR OVERCAST.
5. CLIP THE SEAM ALLOWANCE AT THE UNDER-ARM CURVE.
6. FINISH ALL EDGES OF THE KIMONO BY ANY OF THE METHODS LISTED BELOW:
(A) BINDING WITH DOUBLE FOLD BIAS TAPE
(B) OVERCAST STITCHING THE EDGES WITH A SERGER
(C) TURN UNDER 1/8" AND STITCH IN PLACE
(D) ZIG ZAG OR OTHER OVERCAST TYPE STITCH.
7. PRESS SEAMS AND EDGES SO THAT THE KIMONO IS FLAT AND FREE OF WRINKLES.



8. SHOULDER CLOSINGS

CUT 3/4" WIDE VELCRO (TM) OR OTHER BRAND HOOK/FASTENER TAPE INTO PIECES ABOUT 3/8" IN LENGTH. YOU WILL NEED FOUR SETS OF 3/4" X 3/8" PIECES.

POSITION PIECES ALONG THE SHOULDER-SLEEVE EDGE AS INDICATED BELOW SO THAT WHEN FASTENED, THE KIMONO BACK WILL OVERLAP THE KIMONO FRONT.



SEW VELCRO (TM) PIECES INTO POSITION.

MULTI-SIZED KIMONO FOR PREEMIES

DIRECTIONS for the assembly of the original Kimono pattern.
It's really easy!!!

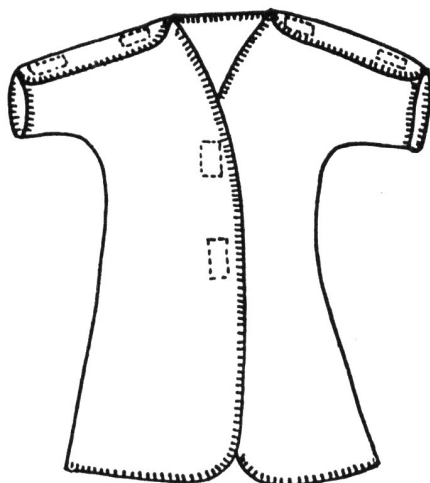

9. FRONT CLOSINGS

Option #1: Cut 3/4" wide velcro into two 1/2" lengths for the front.
(You will need two sets-see illustration)

Position Velcro fasteners on the front as illustrated at left. Sew each into position.

Option #2: Attach ribbon ties instead of the velcro.

NOTE: This kimono opens down the front and across the shoulder/sleeve so that the premie babies can be dressed/undressed without disturbing the tubes & monitors.

SEWING PATTERNS

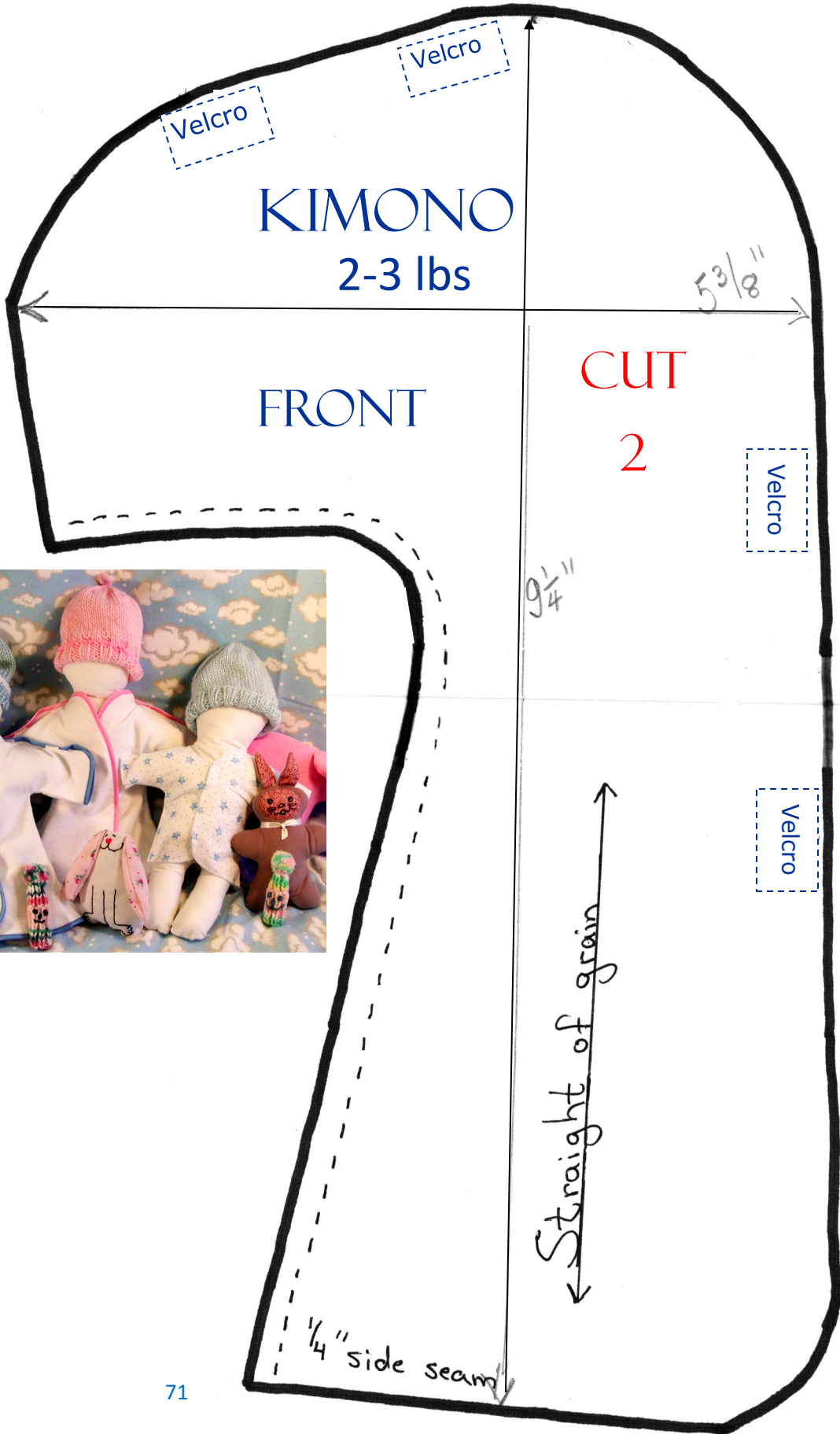



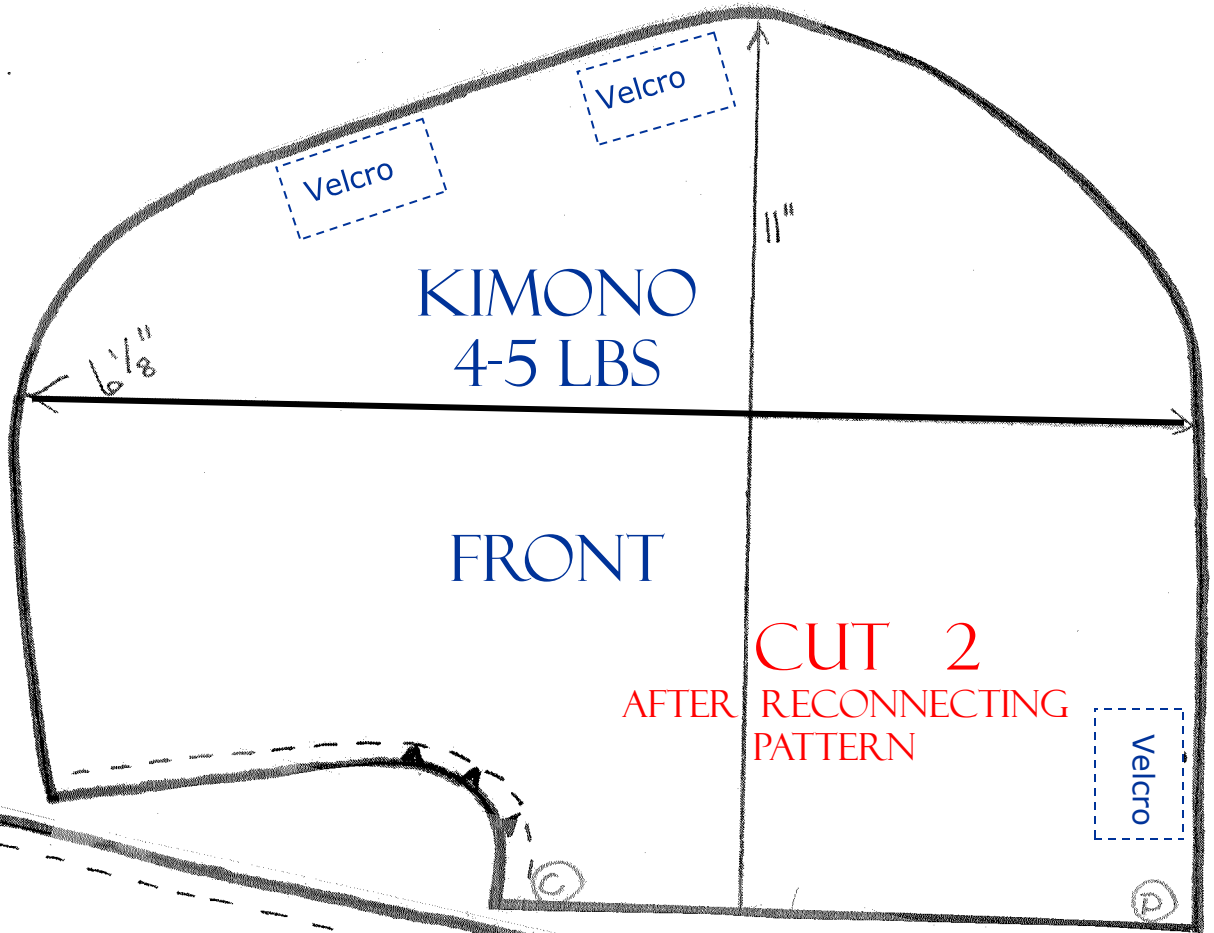

PLEASE check the measurements on this pattern before cutting. It should measure 11" long and 6 1/8" wide where marked. Assembly directions are on page 70

PLEASE
RECONNECT PATTERN BEFORE
CUTTING FABRIC

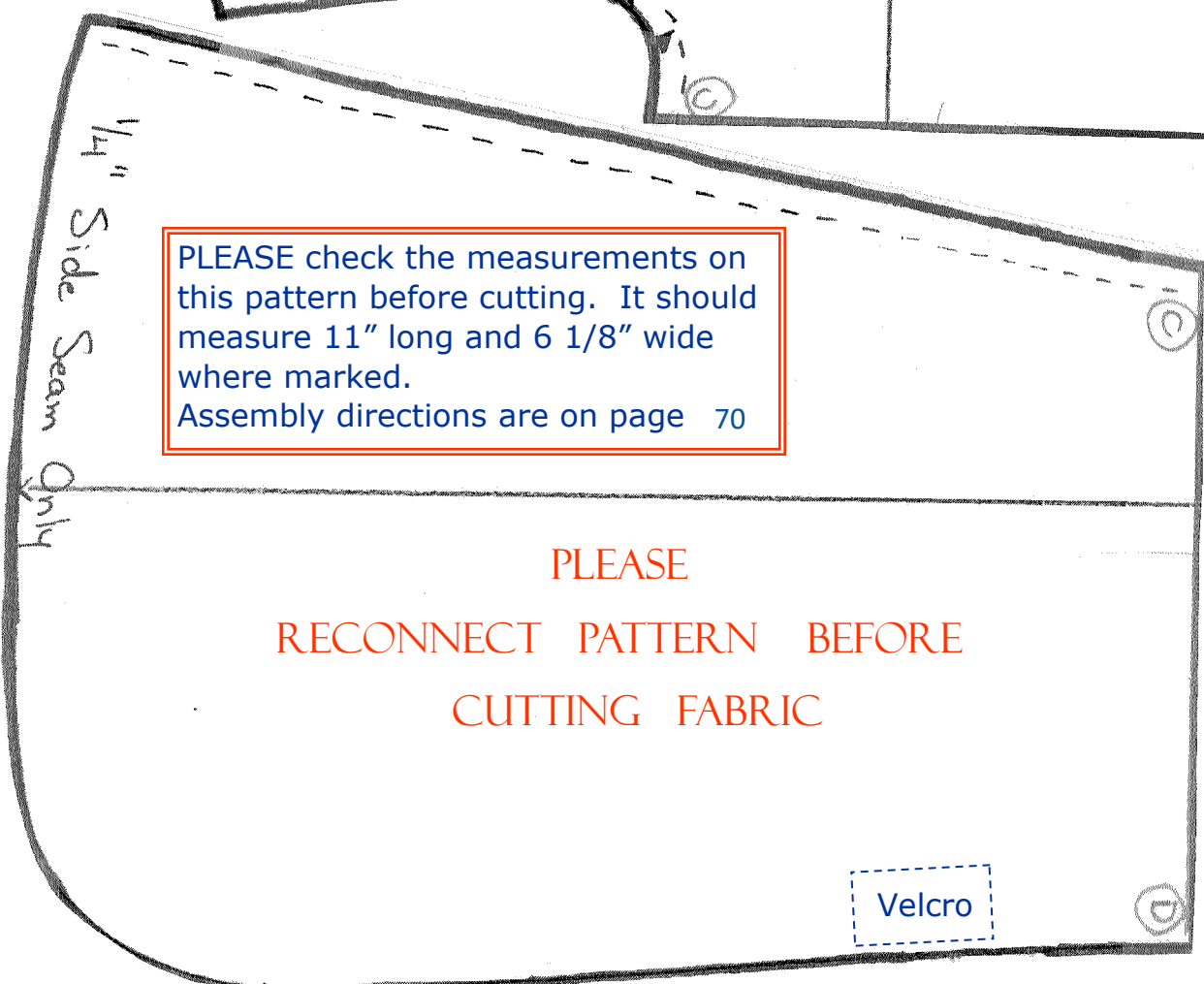

SEWING PATTERNS

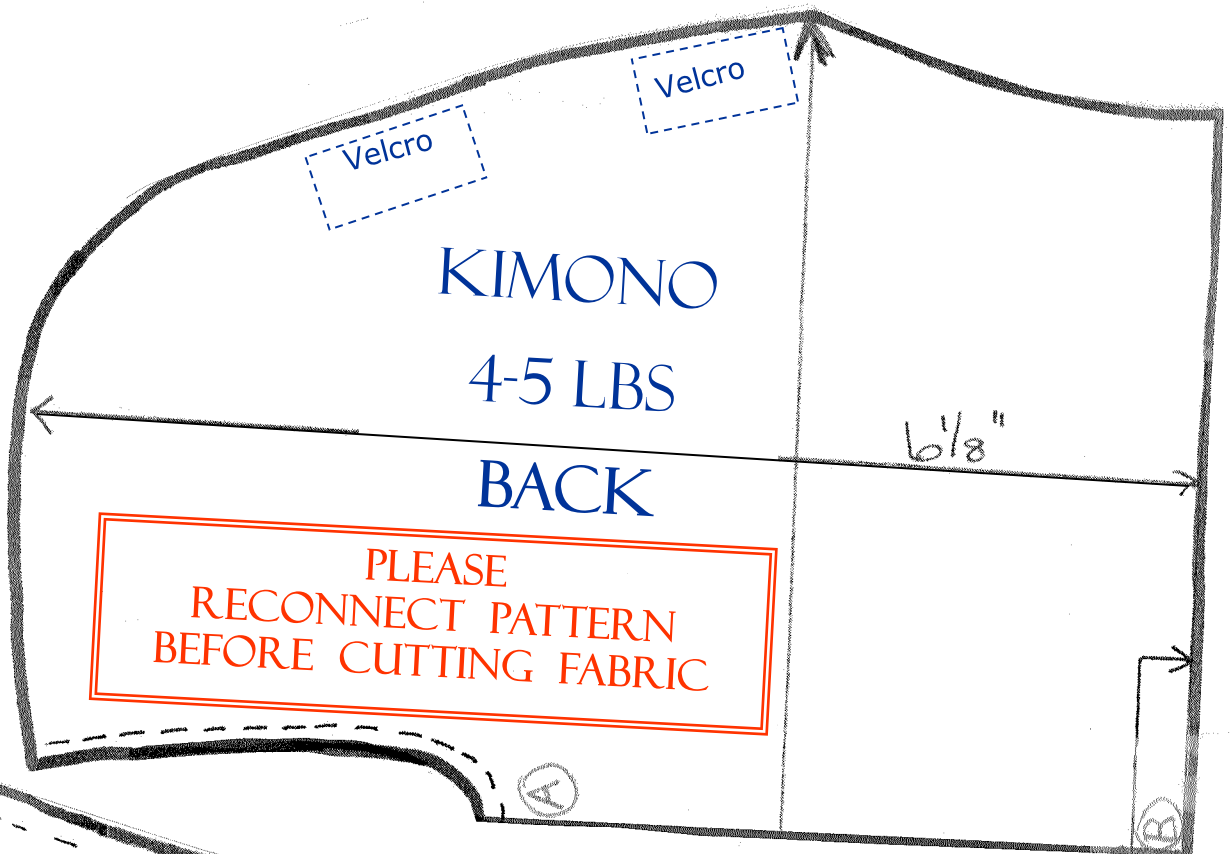

Again, please double check the measurements noted on the pattern for length and width. If an adjustment is needed, take the pattern to a photocopier to enlarge or decrease in size until the measurements are accurate.

Another THANK YOU to Debbie Pfaff for her help sizing this pattern for 2-3 and 4-5 lb infants.

CUT 1 — ON FOLD
AFTER RECONNECTING PATTERN

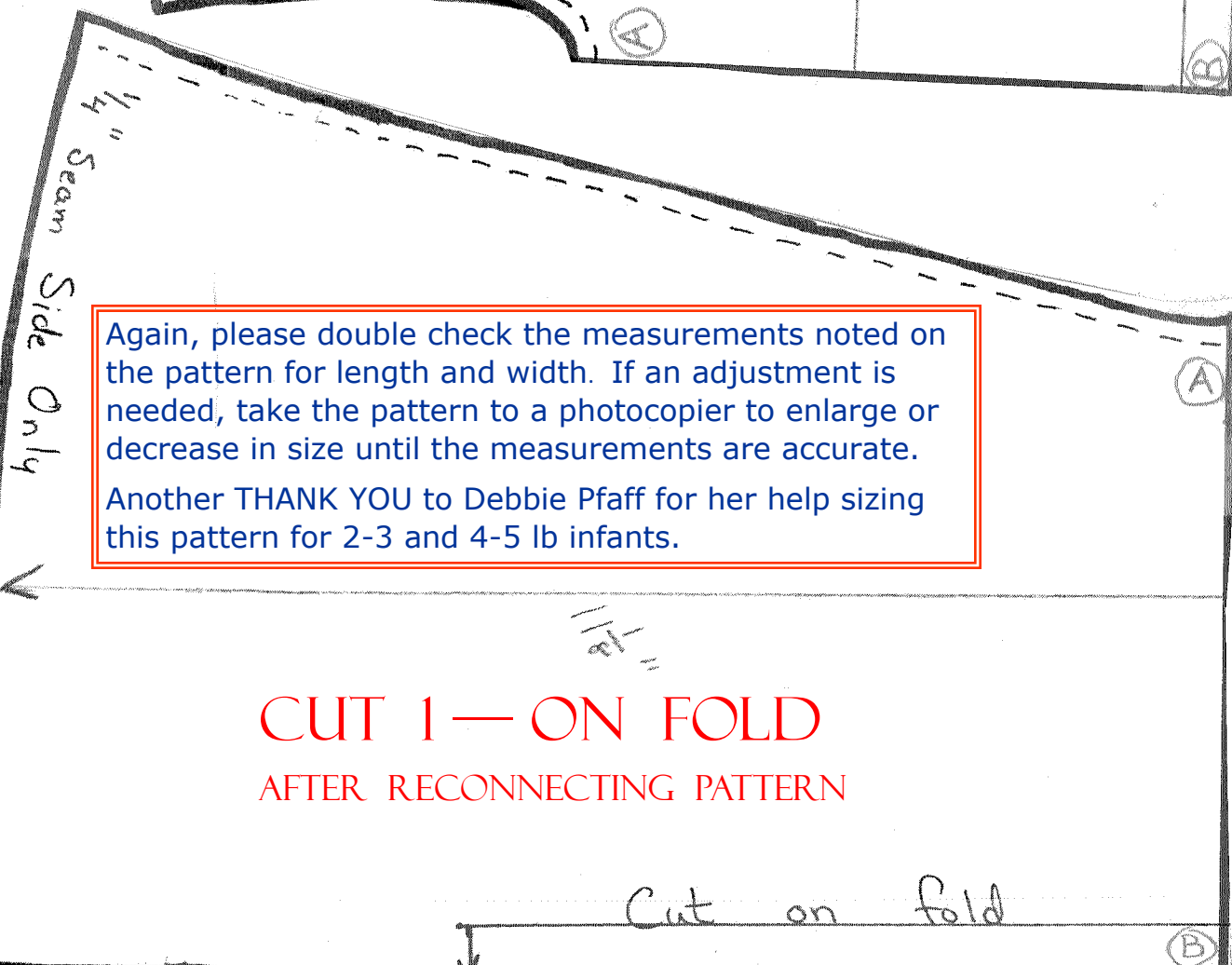

BOOTIE PATTERN TO SEW

© 1983 Diana-Marie Thorpe
Free Pattern: Not for resale

Trace off the pattern piece.
The larger size is full-term and the smaller size is preemie.
Fabric: Soft knits or flannel.
Notions: 1 yard 1/4" ribbon

Directions:

1. Cut out 4 bootie pieces (lining layer and bootie layer)
2. On the bootie layer, make buttonholes as positioned
3. Right sides together, sew center front and center back seam on the bootie layer
4. Repeat for lining
5. Turn bootie right side out
6. Tuck lining inside bootie (toe at toe and heel at heel) and pin together at cuff
7. Top stitch as shown on pattern, all around ankle
8. Finish upper raw edge (zig-zag, serge, or hem)
9. Cut 2 ribbon ties (18" each). Fasten a small safety pin into the end of each ribbon tie and push in one buttonhole and out the other
10. Hand tack ribbon to bootie at center back so that ribbon stays in place
11. Knot ribbon ends to prevent raveling

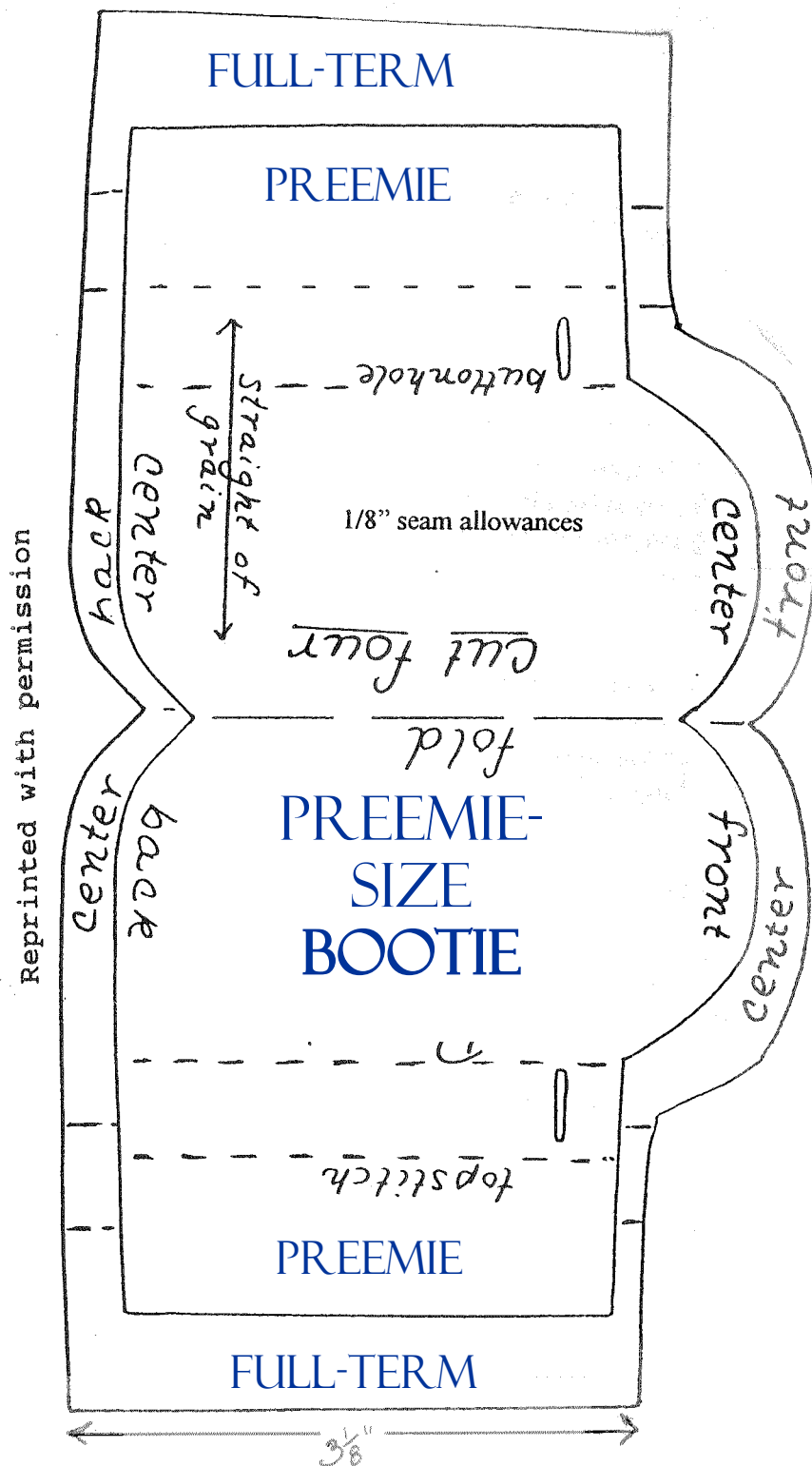

SEWING PATTERNS

BURIAL SHROUD

Pattern designed by Donna Sheffield and given to Care Wear Volunteers to share with participants who sew.

You will find that this small burial shroud does not take much fabric and can be varied depending on the trims available.

Photo far left: The original was made of white fabric on the outside and a soft printed flannel inner layer.

I recommend including the "optional" bottom insert. It provides more space for the infant in this little shroud.

This pattern can be enlarged or decreased to meet the needs of your area hospital. Make a sample and ask if the size is appropriate.



After sewing the two layers together with lace in the seam, attach the ribbon or eyelet lace with ribbon laced through it. As you can see, a 1/4" ribbon by itself is fine.



SEWING PATTERNS

CUT 2 ON FOLD:

- 1 layer for the OUTSIDE
- 1 layer for the LINING

DIRECTIONS:

1. Baste a narrow (1/4" - 3/8") lace up the front edge, across the top and down the other front edge—so that it will extend outside the seam when the two layers are stitched and turned right side out. (No lace on the bottom edge)
2. With right sides together, stitch the 2 layers together up the front edge across the upper edge, and down the other front edge—with lace in between. Do not sew the bottom edge.
3. Clip curved seam allowances. Turn to the right side and press.
4. Attach eyelet lace or ribbon across as seen in photo on page 76. (20" ribbon/10" eyelet lace)

Front Edge

Upper Edge

EYELET RIBBON IS 1" WIDE - RUN 1/4" RIBBON THROUGH



NEEDS 20" OF WHITE 1/4" RIBBON AND 10" OF 1" WIDE EYELET RIBBON

5. Bring curved front edges together overlapping the lace that extends from the seam and pin.
6. Right sides together, pin in the bottom insert piece and sew through both layers—attaching the bottom to the shroud piece.
7. Finish the raw edges of that seam.
8. Turn right side out.
9. Tie ribbon into a bow as shown on page 76.

1/4" seam allowances

Lengthwise Grain Line

PLACE ON FOLD

9 1/2"

Slightly gather this bottom edge before inserting bottom insert piece.



Bottom Insert Pattern Piece

Cut 2 on fold:
1 outer fabric
1 lining fabric

SEWING PATTERNS

ALZHEIMER'S APRON

These aprons help keep Alzheimer's patients occupied and are requested by Frederick Memorial Hospital (Frederick MD) and many other hospitals & medical offices.

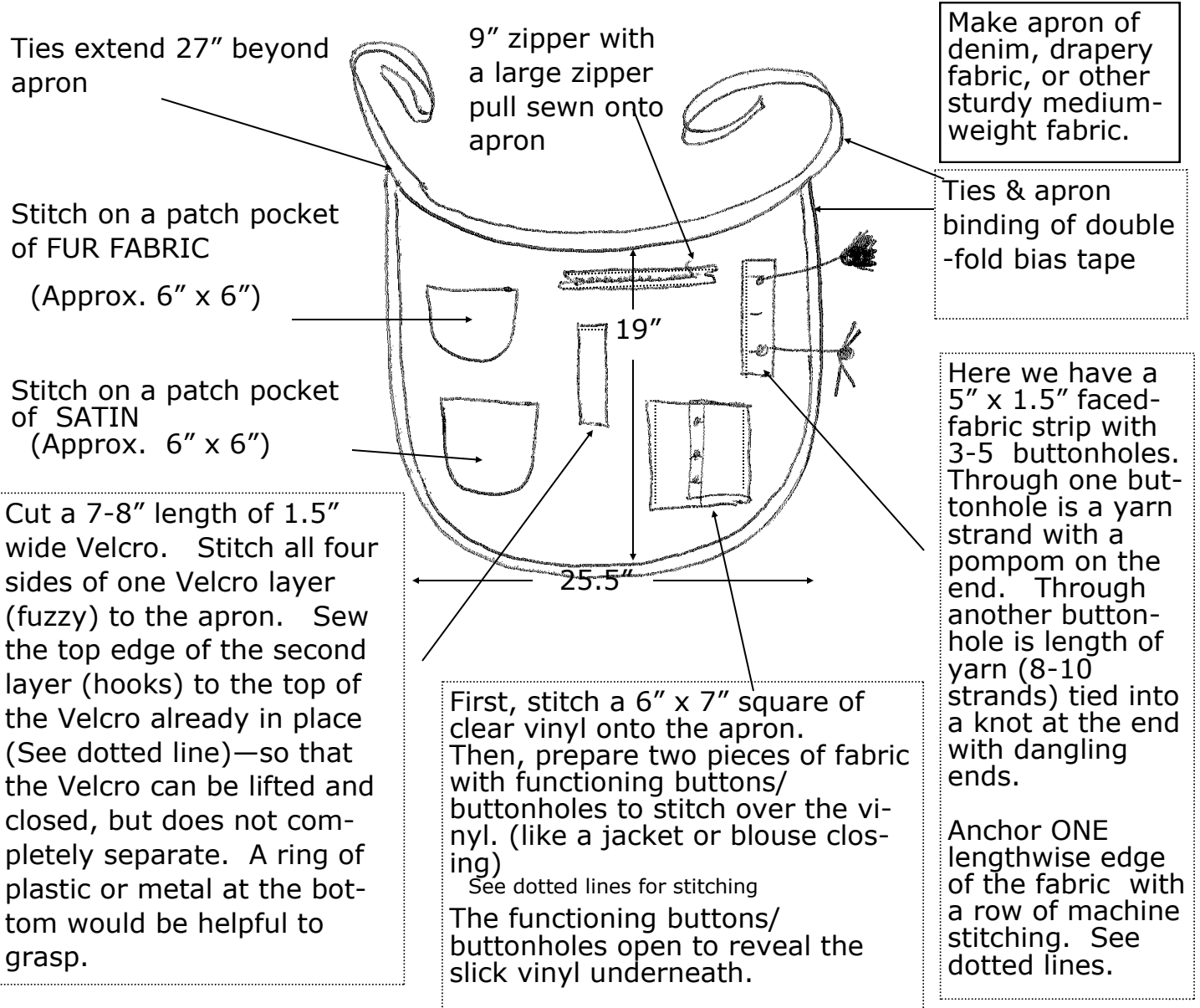

Use an assortment of BRIGHT colors for components. Sizes are approximate and do not have to be exact. My diagram is not exactly to scale!



ALZHEIMER'S APRON II

Here is another design for an Alzheimer's apron to keep patients occupied while in the ER or other hospital department. Also welcomed at physician's offices.

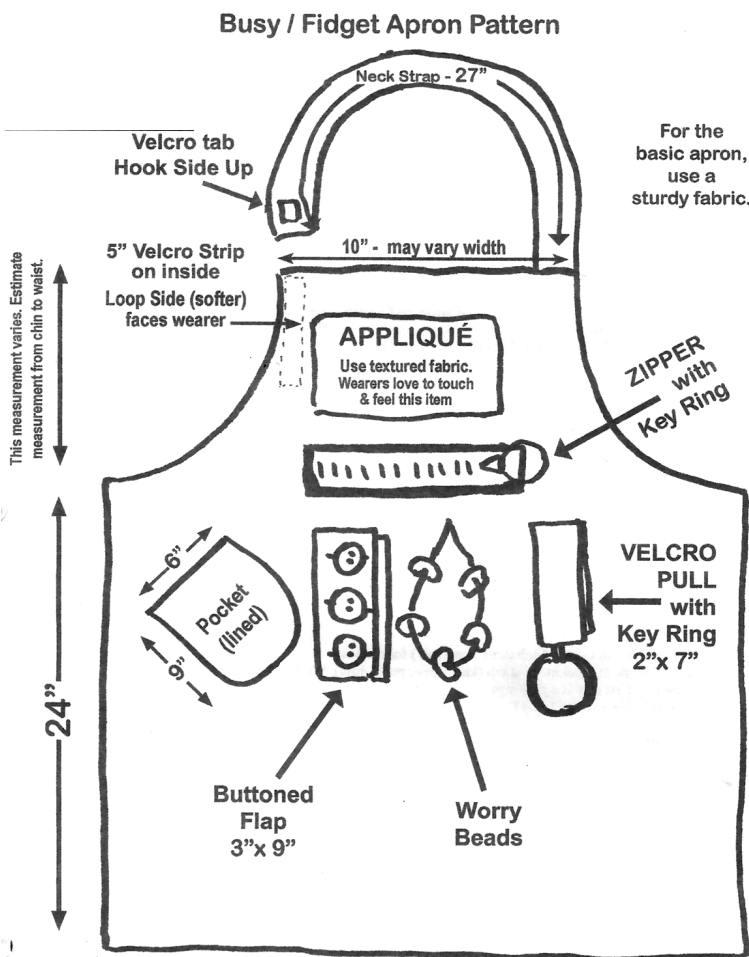

TWIDDLE MUFFS

(a.k.a. Alzheimer's Activity Muffs) can also be sewn.

Care Wear Volunteers participant Laurinda Stokes made this—her first prototype of the sewn "Twiddle Muff".

The muff is made out of a sturdy cotton with a batting interior plus a fleece lining for extra warmth.

Sensory items include:

- Zipper
- Assorted Buttons
- Tassel
- Satin Ribbon
- Strip of Elastic
- Toggle
- Velcro Strips
- Beads
- Knotted Soft Rope
- Dangles on Metal Ring

See page 31 for measurements and construction instructions.



SEWING PATTERNS

X-SMALL BOY'S GOWN

NOTE: This pattern can be used for infant girls by substituting a ribbon rose or bow for the neck tie.

Cut out pattern pieces. Embroider sleeves on marked lines. Turn under sleeve ends $\frac{1}{4}$ " and sew. After sleeve is sewn to bodice, turn under cuff and sew with tiny stitches by hand, catching the embroidery lines so that you can't see stitches from the top.

Embroider outside collar line on bodice top only. Sew narrow bias to bodice front at waistline, before attaching the skirt. Gather skirt pieces and pin to bodice top. Turn outside length of skirt back under $\frac{3}{4}$ ". Turn end under $\frac{1}{4}$ " leaving $\frac{1}{2}$ " for hem. Press and sew all the way down.

After skirt is together, sew gathering lines on bottom of skirt, (2 rows). Pin sacque bottom to bottom of skirt and gather to fit. Sew together. Sew lining bottom to cover raw seams on the inside. Turn on right side. Tack right side of skirt to left side, $2\frac{1}{2}$ " up from sacque bottom. Cut two pieces of $\frac{1}{8}$ " ribbon, 9" long and tack on back of gown seam at neckline about $\frac{1}{4}$ " in, on each side.

To make tie:

Use bias tape, $5\frac{1}{2}$ " long. Press flat. Turn short ends under $\frac{1}{4}$ " and press. Bring corners down to form a peak. Turn left side under a scant $\frac{1}{2}$ " and press. Turn right side under a tiny bit and then again to form a seam line, and pin. Take tiny stitches all the way down by hand through back only to press again. Do not stretch. With right sides facing you, turn in half. Tack $\frac{1}{2}$ " down, right over left. Bring peak down to make what looks like a tie knot, and sew on back to secure. Tack to bodice where marked. Use the same color bias tape for the ties as you use at the waistline.

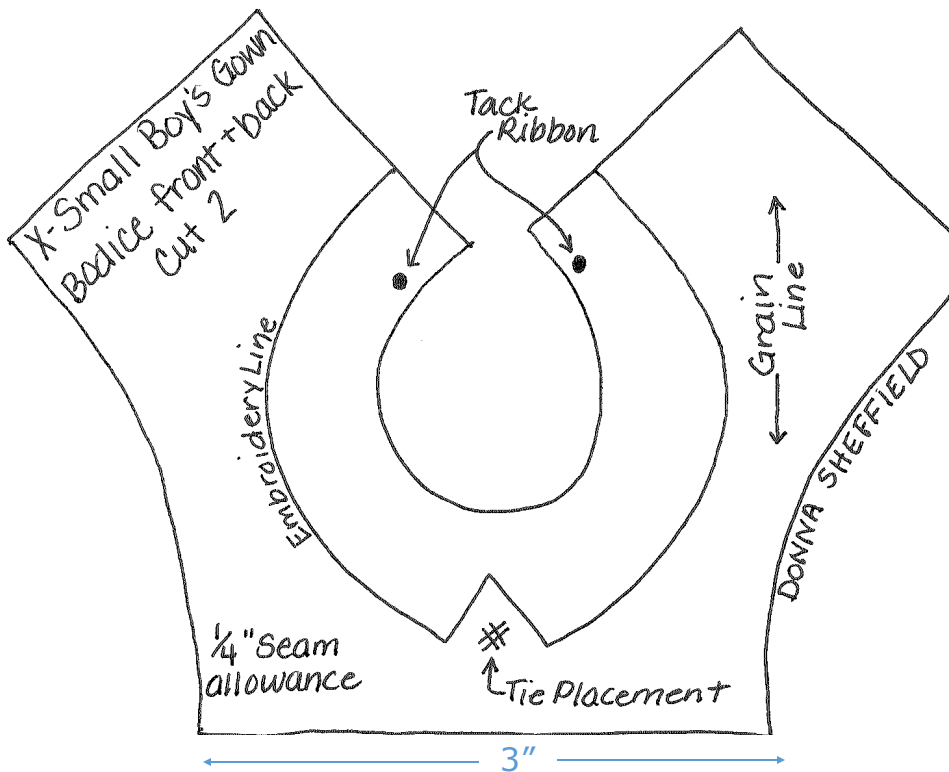

Donna Sheffield designed this gown and shared it with Care Wear Volunteers. For three larger sizes, see the December 2002 newsletter on the Care Wear Volunteers website: <http://www.carewear.org> See the September 2003 newsletter for another gown called Lorrabelle's Gown (open at the bottom) in three sizes.

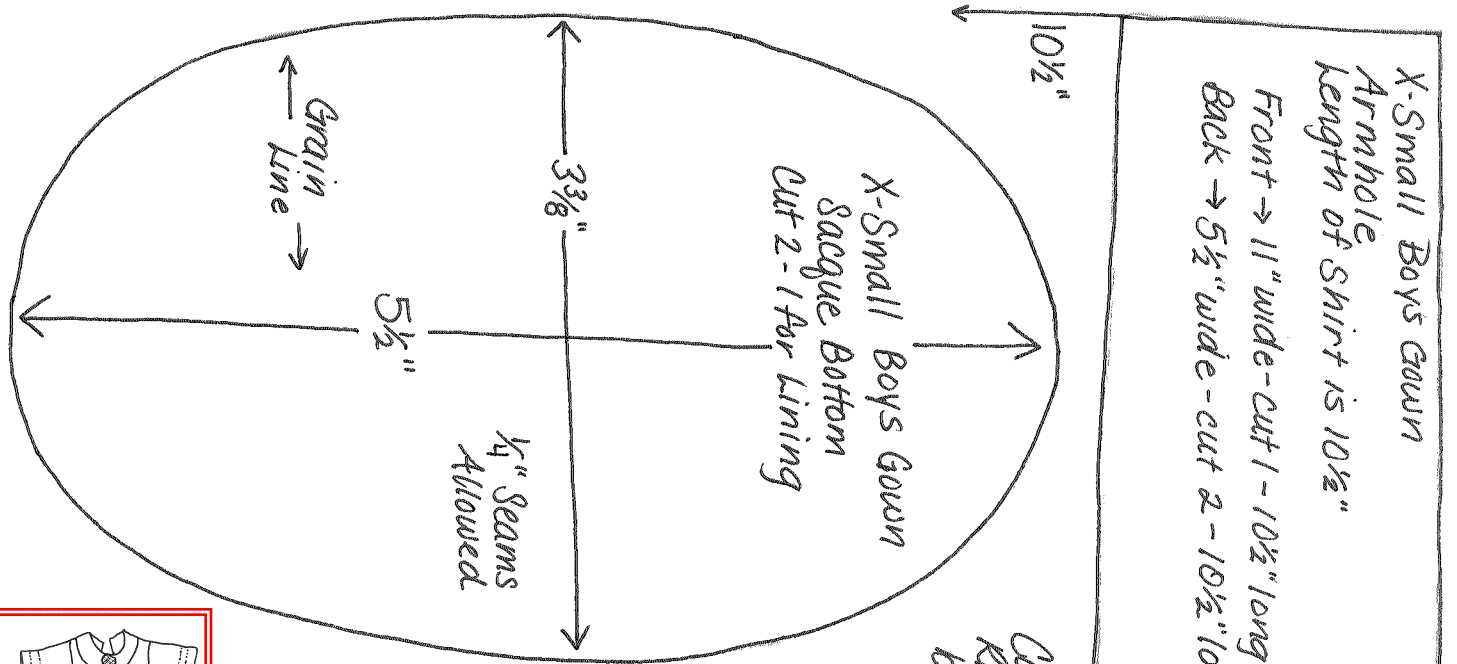

Cut 2 pieces of 8" Ribbon and tack to bodice where marked

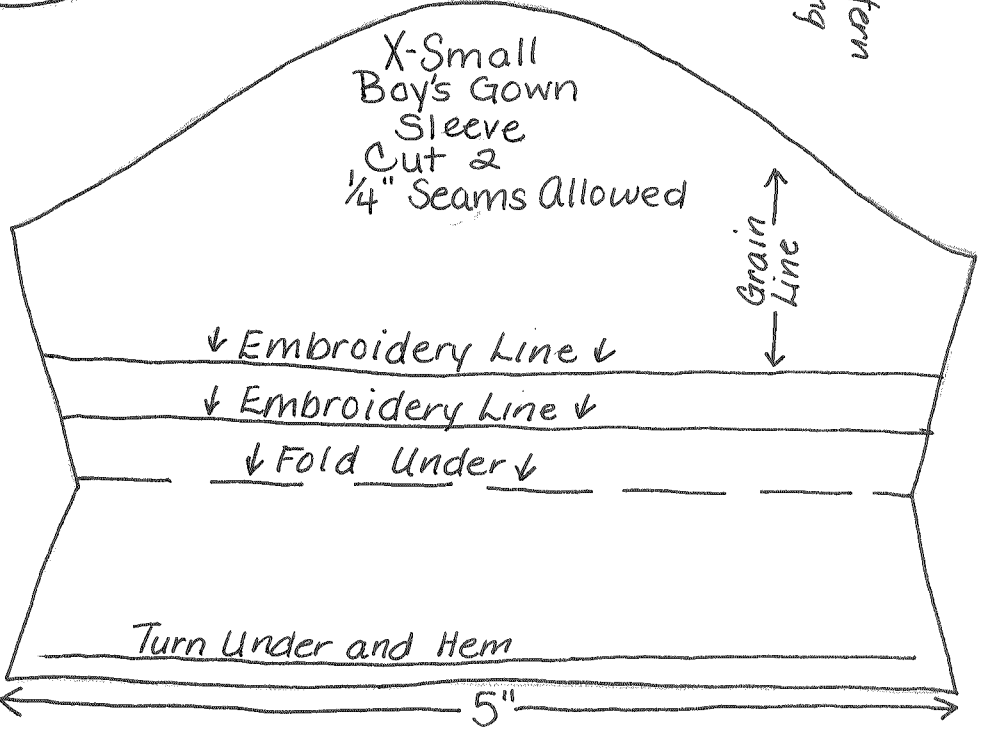
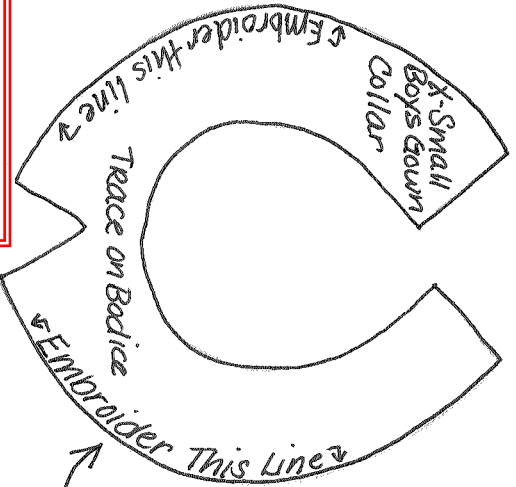
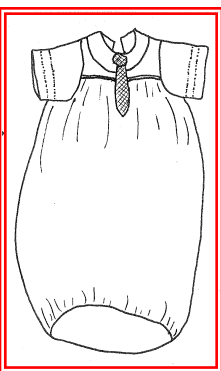
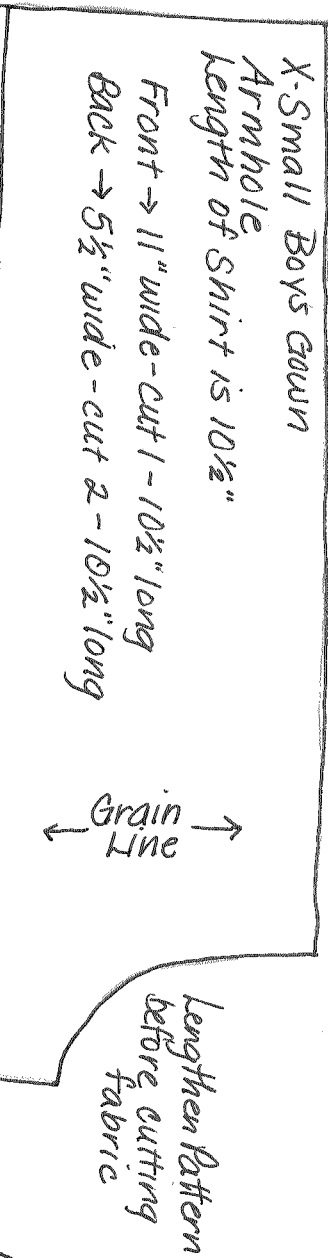

Embroider on this line top bodice only. I did the embroidery with regular colored thread on the sewing machine. Went over it twice. Do the same on the sleeves before sewing them.

SEWING PATTERNS

NECK PILLOW



ADD SEAM ALLOWANCES
to this pattern before
cutting

Neck pillows are requested by many hospitals, including Frederick Memorial Hospital, Frederick MD., for patients of all ages. After surgery, many patients need a little support while they rest, eat, etc...

FABRIC: Fleece or other soft fabrics

DIRECTIONS FOR FLEECE & OTHER NON-RAVELING FABRICS:

1. Cut 2 of the pattern positioned on the fold.
2. (REMOVE THE EXTENSION AT THE OPENING)
3. Position the 2 layers WRONG SIDE together.
3. Pin seam allowances around the outside of the neck pillow.
4. Sew around the neck pillow leaving an opening (4"-5") for stuffing
5. Stuff with fiberfill.
6. Stitch the opening closed.

DIRECTIONS FOR FABRICS THAT RAVEL

1. Cut 2 of the pattern positioned on the fold.
2. Position layers with RIGHT SIDES together.
3. Pin seam allowance around the pillow.
4. Sew around the pillow leaving an opening of 4" to 5" for stuffing.
5. Clip seam allowances on curves.
6. Turn pillow to right side.
7. Stuff with fiberfill.
8. Stitch the opening closed.

ON FOLD

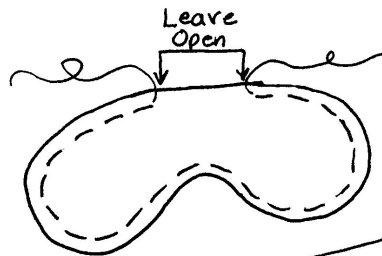

Leave open for stuffing

SEWING PATTERNS

COUGH PILLOWS

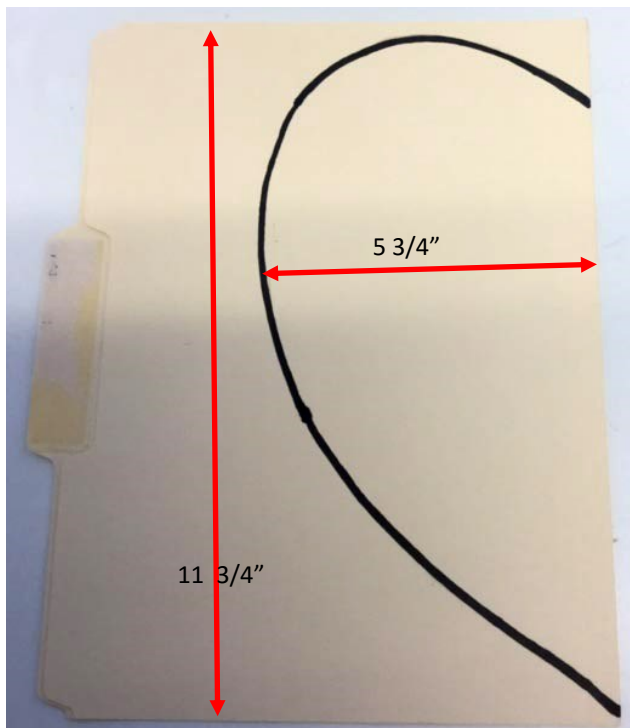

There is no standard size for heart-shaped cough pillows. Some hospitals provide 18" tall heart-shaped pillows. The suggested size above is adequate to cushion, but does not use as much fiberfill as the 18" size. Using a 9" x 11 3/4" file folder, draw a half heart at the fold—as shown above. Cut out around the marking and open the file folder to get the full heart pattern.

1/4" seam allowances.

Cough Pillows are given to patients after surgery—in case they have to cough or sneeze. These pillows are handy to place under seat belts when traveling in a vehicle. The sizes and shapes vary. 9" x 12" finished rectangle is a popular size and is the size used by the local hospital here in Frederick, Maryland.

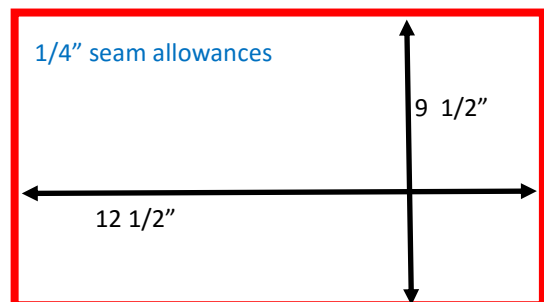

Port Softies for Chemotherapy Patients

<https://frommycarolinahome.wordpress.com/2015/05/20/port-softies-for-chemotherapy-patients/>

See this source for directions for making this padded cushion or design your own.

SEWING PATTERNS

BURIAL GARMENT FOR BOYS

(Printed in the June 2016 newsletter (pp. 14-19) and modified from the Boy's Jumpsuit Pattern in March 2016 newsletter—page 28).

I modified this pattern with the goals of making the garment easy to sew and easy for nurses to dress the infant. Hospitals request burial garments that are open all the way down the back and easy to get on and off.

DIRECTIONS:

1. Before cutting fabric re-connect the two pattern pieces for the front & back. (It was not possible to reprint the 17 1/2" pattern pieces on one page.)
2. Cut out the back (2 layers) and front (on fold) from the main fabric.
3. Cut out the vest pattern (2 layers on fold) from a second fabric.

VEST:

1. With right sides together, sew neck seam—down one side & up the other—as shown with red arrows. (1/4" seam allowance)
2. Then, sew armhole, side seam, & bottom seams in one continuous seam. (Pardon my poor attempt to show that seam with a curved line. Follow the pattern edges exactly.) Do NOT sew shoulder seams.

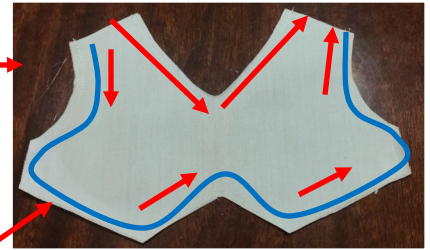

3. Clip neckline & armhole seam allowances. Trim off points of seam allowances.
4. Turn vest to right side through one of the open shoulder seams.
5. Press flat.

ASSEMBLY:

1. Pin finished vest to the garment FRONT—aligning shoulder seams.



2. Top stitch vest to front around the neckline & the armhole-side seam-bottom edges.
3. Sew garment FRONT to BACK along the shoulder seam.
4. Seam finish (optional) the shoulder seam & press toward the BACK.
5. Open the garment so that sleeves are flat & finish the bottom edge of the sleeve.



6. Turn up a 1/4" hem on the bottom of the sleeve and stitch in place.

7. Sew FRONT to BACK along side seam (side seam and along sleeve to the hem).

Be sure that you do not catch the vest as you sew the side seam.

NOTE: If you sew the side seam with the garment FRONT facing up, you can see the stitching that attaches the vest and you can miss catching the vest in the side seam.

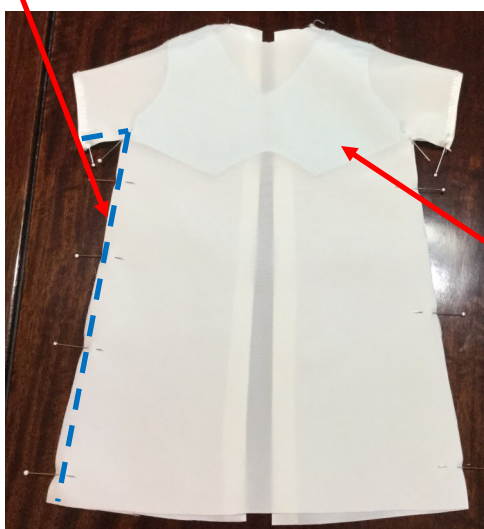
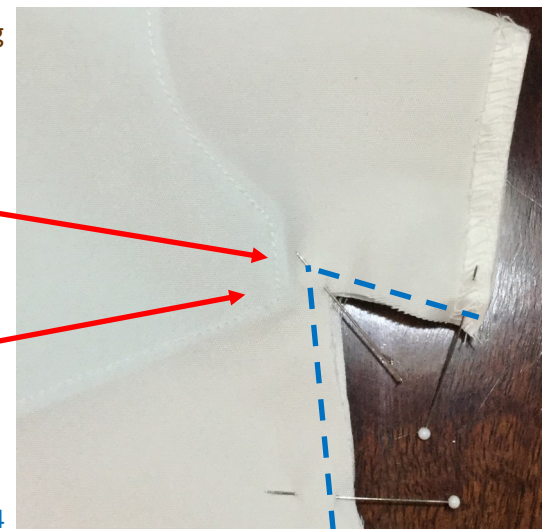

9. Press the seam allowance of the center back to the wrong side. Do NOT sew any of the center back seam.
10. Finish the bottom edge of the garment & turn up 1/2" hem/casing. Stitch approx. 3/8" from the bottom edge.
11. Thread a 1/8"-1/4" satin ribbon through the casing at the bottom edge from center back to center back. Leave enough ribbon on each side to tie a bow.



12. Cut a 28" length of double-fold bias tape. Locate the center (14") and position that center point at center front. Pin remainder around the neckline to the center back opening (keeping center back seam allowance folded to the underside.)

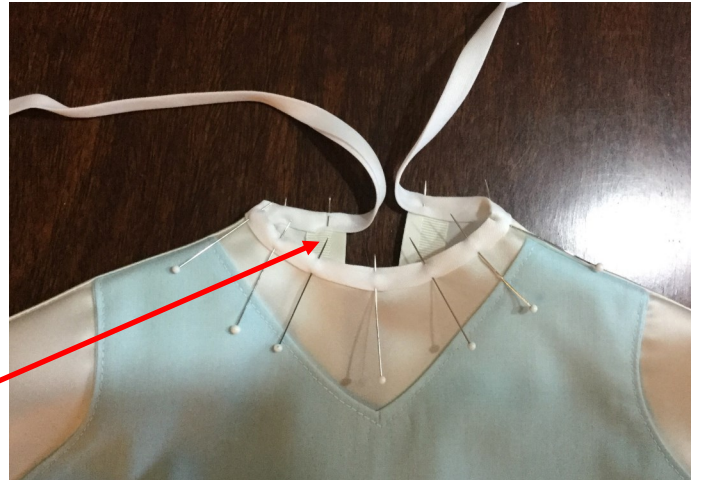

13. Stitch the double fold bias tape from end to end. I used a zig zag stitch because it is helpful in sewing on a curve. The zig-zag will catch the fabric and stay securely attached. Tie a knot at the ends of the bias tape.

14. Sew on two buttons in center front of the vest.

15. Tie a bow at the center back neckline and center back hem.



There are a number of burial gown patterns that are appropriate for girls, but few that really look "boyish." If, however, you wish to modify this pattern for girls, you could replace the vest with a "collar" or "pinafore" that is caught in the shoulder seam the same way that the vest is caught. Trim with lace or flower &/or flower appliqués.

SEWING PATTERNS

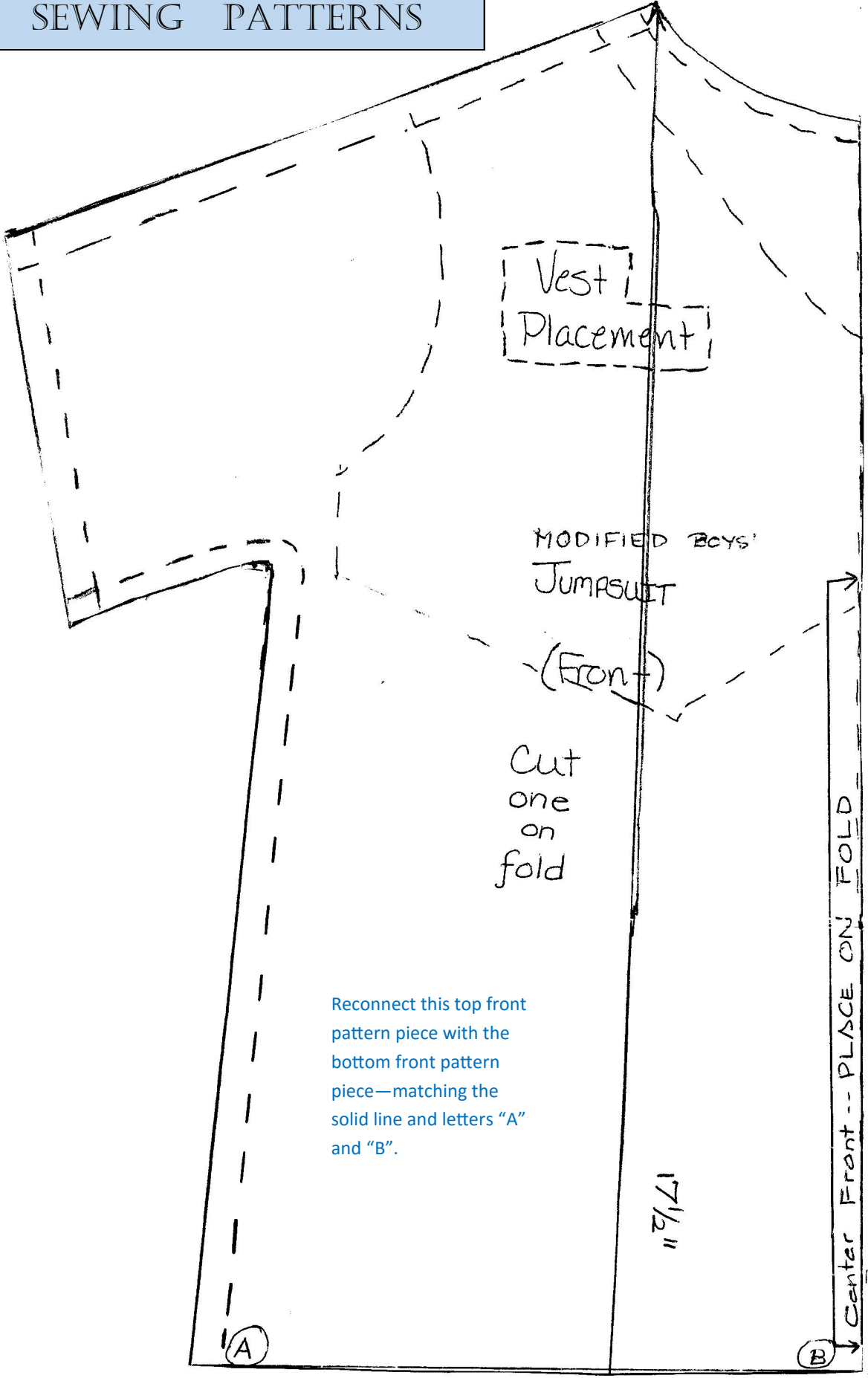

Reconnect this top front pattern piece with the bottom front pattern piece—matching the solid line and letters "A" and "B".

SEWING PATTERNS

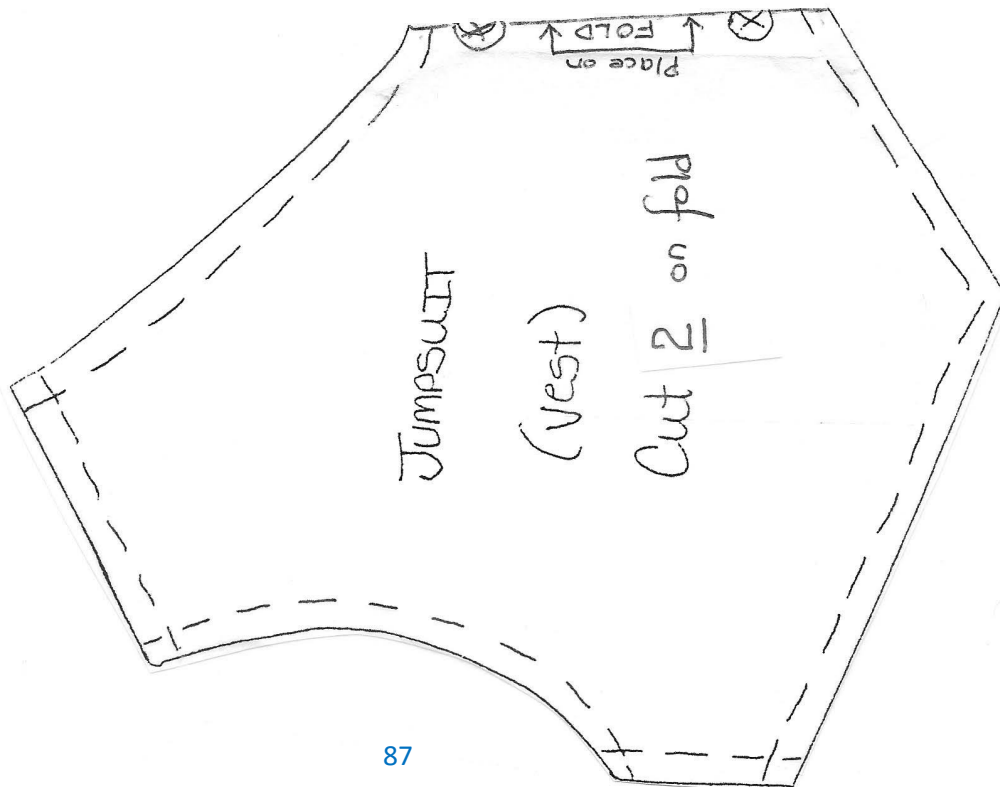
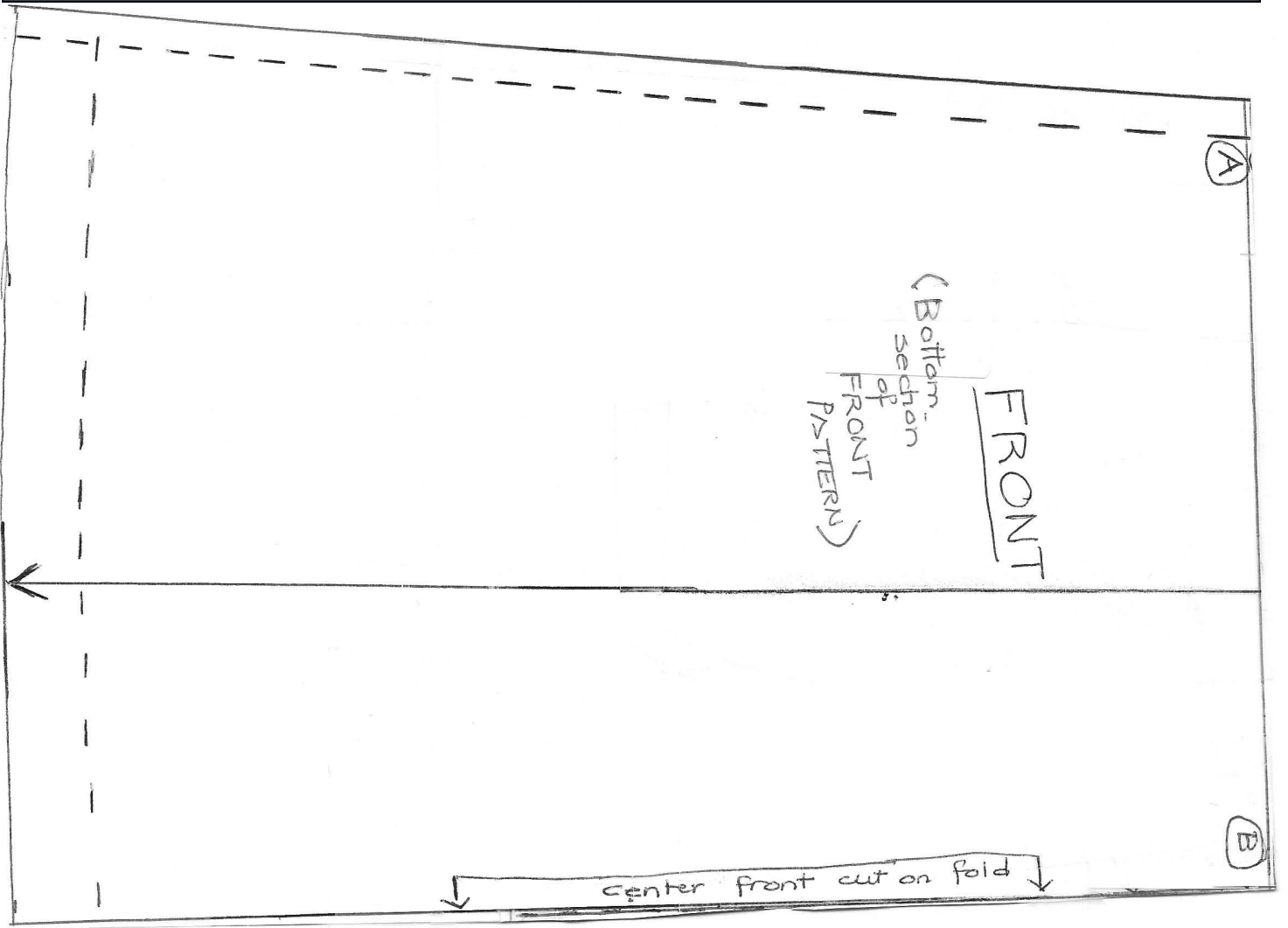

SEWING PATTERNS

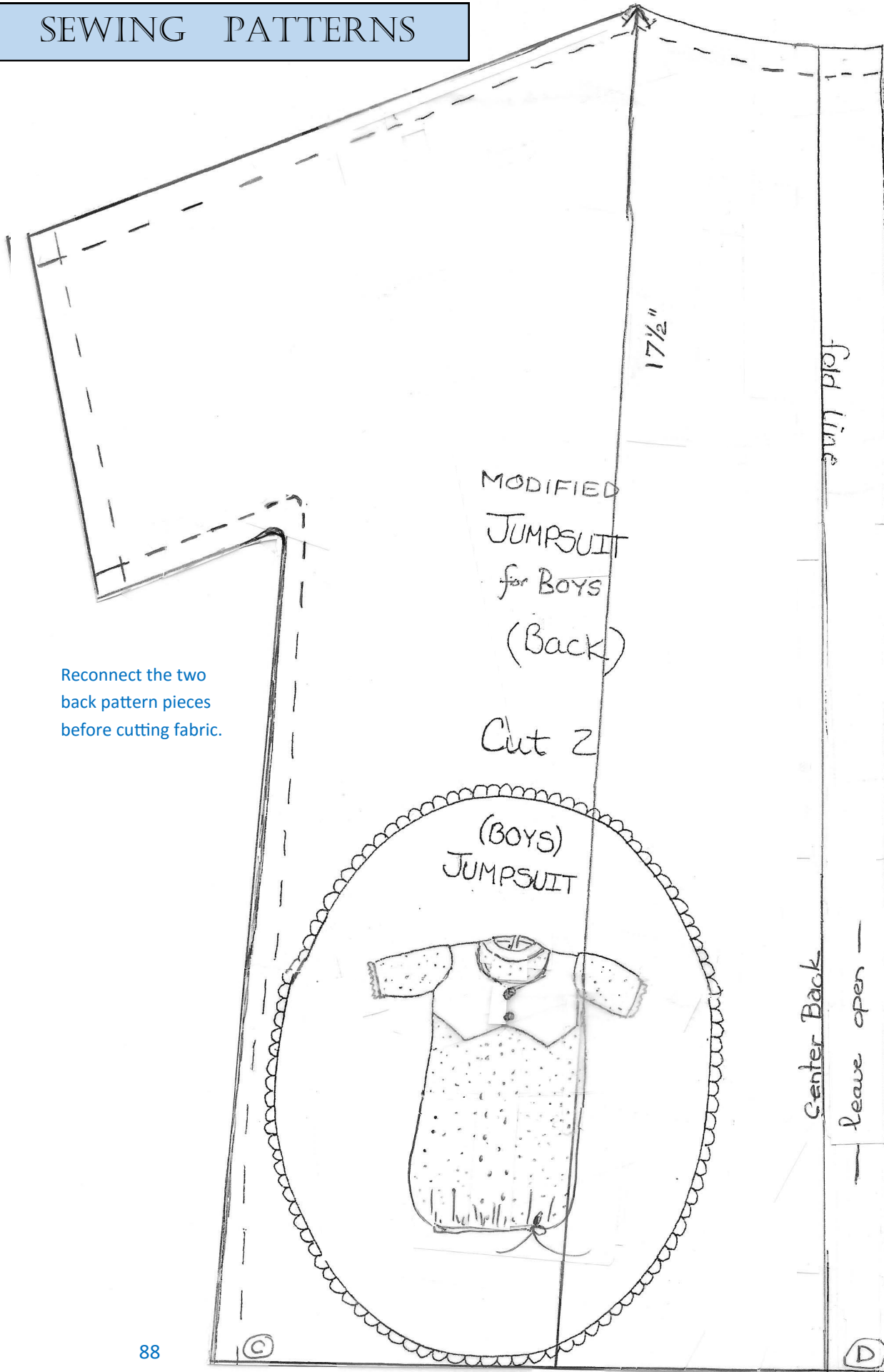

Reconnect the two
back pattern pieces
before cutting fabric.



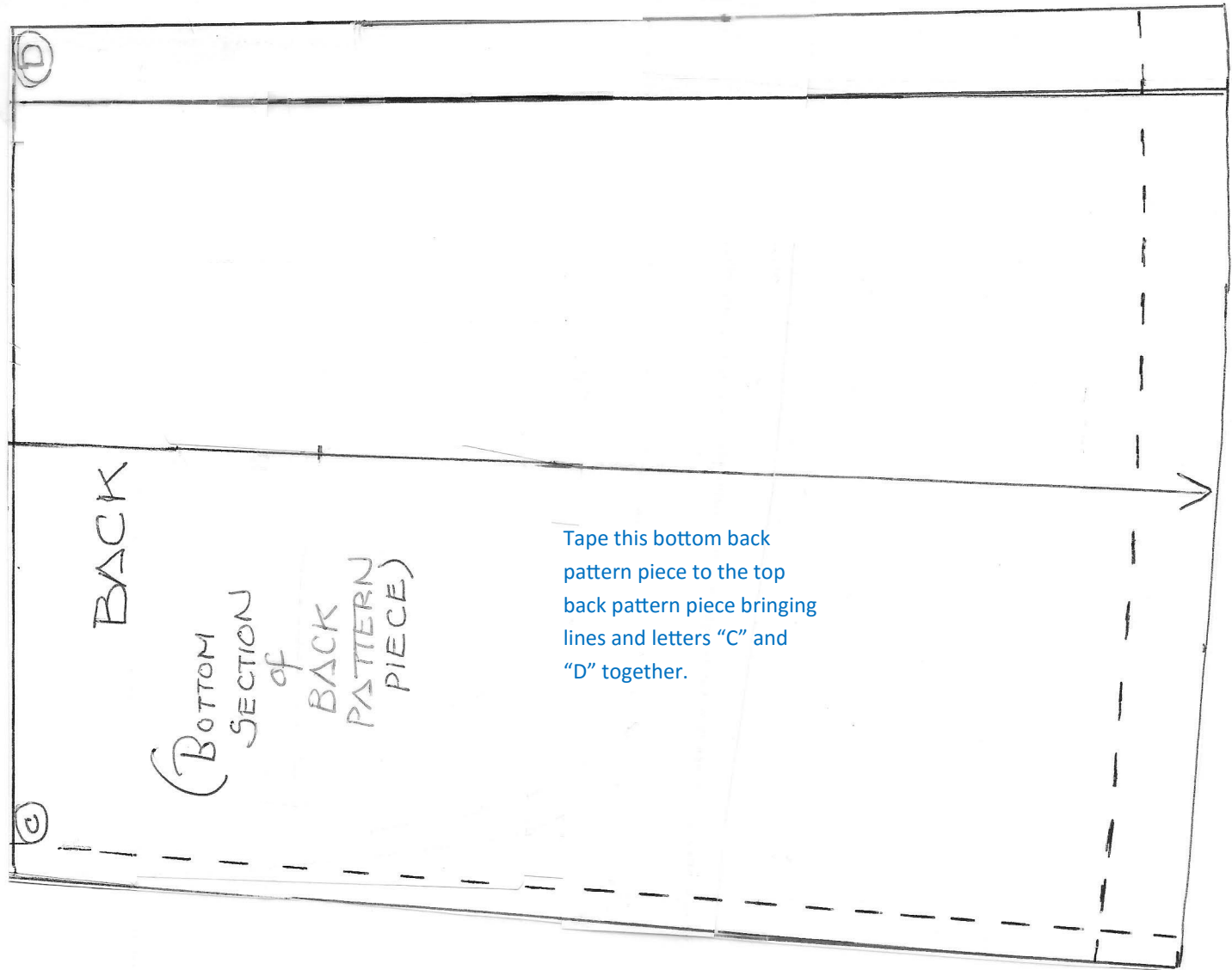

OTHER SEWING PROJECTS found in a newsletter on our website (www.carewear.org)

- CUDDLE COVER: September 2010 (P. 17)
- SHARE SQUARES: June 2011 (p. 25)
- COMFORT DOLLS: March 2012 (P. 22)
- DRAWSTRING BAG: September 2016 (p. 26)
- HOSPITAL GOWN FOR MEDICAL-SURGICAL DOLLS: March 2017 (p. 20)
- POSITIONING SNUGLER: June 2008 (p. 8)
- SEWING FOR NURSING HOMES: Sept 2008 (p. 18)
- SCRUB CAPS: December 2008 (p. 17)
- QUILTED SHAWLS: September 2012 (p. 10)

FLEECE SHAWLS

Cut fleece into rectangles (full width-56"-66") and 18"-20" wide. Either cut fringe on the short edges or serge all the way around all four edges. Fleece shawls are appreciated by men in cancer therapy.



SEWING PATTERNS

TOTE BAGS

Tote bags are welcomed by the local Cancer Therapy Center—to help patients carry shawls, hats, nutrition beverages, and printed materials. There is **NO STANDARD SIZE**. Make the tote bag large enough to carry all of the above-mentioned items, but vary the size according to the fabrics on hand. Make your tote bags **COLORFUL** and **CHEERFUL**!

DIRECTIONS:

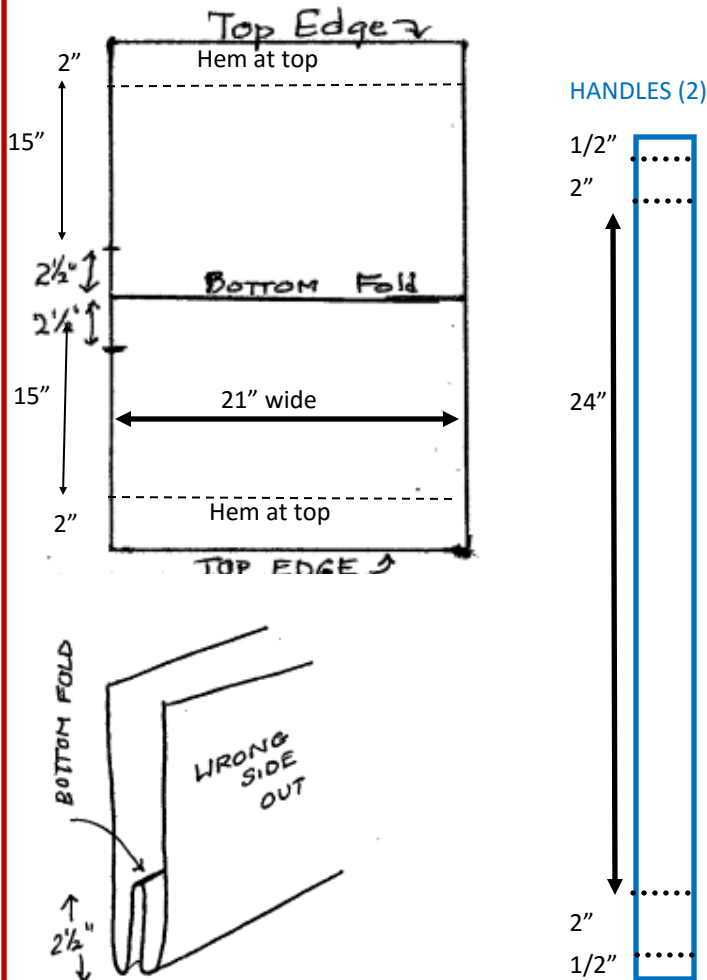

OF COURSE, you can adjust those measurements to accommodate the available fabric.

This **LARGER TOTE BAG** (with expansion pleated bottom) was copied from a tote bag I have at home. It measures 21" wide, 15" tall, & has a 2.5" expansion pleat at the bottom. If you need to piece fabrics, position a seam at the bottom instead of a fold.

Handles measure 24" from edge of tote bag to edge of tote bag. Each handle needs about 1/2" to turn under the raw edge, then 2" along the top hem, then 24", then 2" and then another 1/2" to turn under. See diagram for each strap at left.



Locate the center of the tote bag at the top edge and measure 3 1/2" to either side and mark with a pin. Position the handle ends along that 3 1/2" pin marking (7" apart).



SEWING PATTERNS

SMALLER TOTE BAG WITH SQUARED CORNERS

These tote bags measure approximately 15" wide and 17" tall.



Directions for Squared Corners:

Align the stitching line of one bag side seam with the stitching line of the bag bottom seam or fold line. Draw a line 1"-1 1/2" from the corner (red dotted line below). Stitch across the line to box the corner & backstitch at the start and the end. Trim 1/4" from the stitching line. Repeat for second side. Handle size remains the same as on page 90.

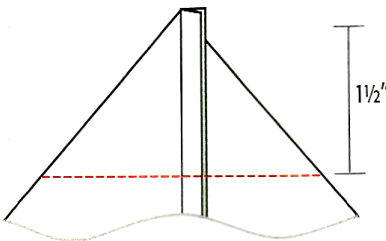

TOTE BAGS FOR CHILDREN

This smaller tote bag is appropriate for children whose toys, games, and belongings clutter tray tables and fall to the floor. Children often fall out of bed reaching for items that have fallen to the floor. Use colorful prints and cheerful designs that will make the young patient smile.

Handle Measurements for smaller tote bags for children: Handles measure 16" from edge of tote bags to edge of tote bag. (Substitute 16" for the 24" in the handle diagram on page 90.)

It is OK to make simple tote bags without expansion pleats or squared bottoms and it is OK to adjust the size to accommodate the available fabric.



From:
 Care Wear Volunteers
 Bonnie Hagerman
 102 Mercer Court #23-5
 Frederick, MD 21701-4070



TO:

FELT FINGER PUPPETS

Materials:

- Felt scraps
- Scissors
- Glue
- Needle/Thread
- Sewing Machine
- Embroidery Floss
- Marker or textile paint

Directions:

- Cut 2 pieces of felt for the body (approx. 2 1/2" length).
- Position ears between two body layers. Sew together around outer edge with a close zig-zag or other stitch—leaving the bottom open.
- Make face (eyes, etc.) with markers, textile paint or embroidery floss.
- Experiment with different shapes & sizes of felt to create a menagerie of finger puppets. Here are some ideas.

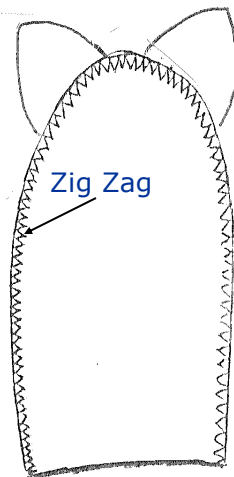

CAT



DOG

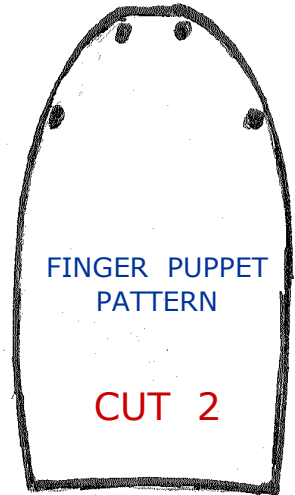

EAR PATTERN



RABBIT



ELEPHANT



MOUSE

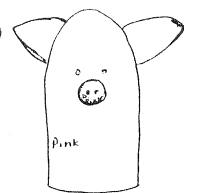

PIG