



Care Wear Volunteers Inc.

Newsletter

A Quarterly Publication of Care Wear Volunteers, Inc.

SEPTEMBER 2013

Care Wear Volunteers
 Bonnie Hagerman
 102 Mercer Ct #23-5
 Frederick, MD 21701
 Tel: 301-620-2858
 FAX: 301-620-2858
 Website:
 www.carewear.org
 E-Mail:
 carewear@comcast.net

MORE HANDSOME YOUNG MEN!



WELCOME
John & Vincent!!!!
 These handsome young men are the great grandsons of my neighbor & friend Eleanor Bromfield. They were born at Frederick Memorial Hospital in Frederick, MD and weighed 3.5 & 4.0 lbs. Adorable hats!!!!

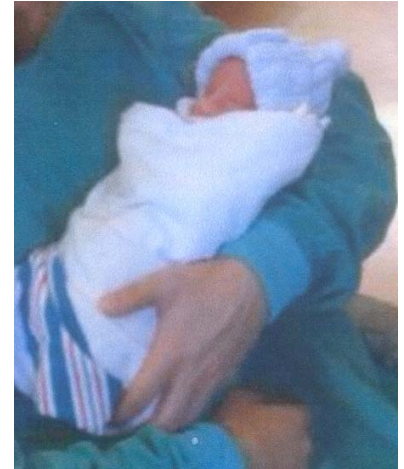

PLEASE be sure to send address changes & corrections to Bonnie. Bulk-rate mail that cannot be delivered is discarded.

WELCOME to Cassius Lee Osward who was born on Memorial Day, May 27th at 9:35am. Cassius arrived a few days ahead of schedule, but weighed 5 pounds + 6 ounces.

More photos on page 3.



INSIDE THIS ISSUE:

| | |
|-----------------------------|-------|
| Letter from Bonnie | 2 |
| Crochet BIB | 14-15 |
| Knit BLANKET | 16 |
| Crochet BOOTIES | 18-19 |
| Cocoon & Hat (Knitting) | 20-21 |
| T-Strap Booties (Crochet) | 22 |
| Receiving Blankets (sewing) | 30 |

Thought I'd take the liberty of sending you another baby picture--the baby for whom I knitted the Wiebke layette. At 9.6 lbs, fortunately he was not an "at risk" baby! But unfortunately, the parents did not send a picture of him wearing any of the layette items ;-(He is Thomas Wesley Holcombe IV and we will get a 4-generation picture when we go to Germany this summer.

Faith (see update on page 6)



Letter from Bonnie.....

Greetings to everyone reading this quarterly newsletter. I hope that you are enjoying knit, crochet, and/or sewing projects that will comfort hospital patients and others in need of warmth or an expression of caring. Thank you for all that you do.

I am always concerned when I learn that a hospital stops accepting donated items. Obviously, hospitals are very concerned about their liability when distributing donated items to patients. You cannot sterilize all that you donate, but you do need to be careful that your donated items are clean, free of dust and cat/dog hair, and free of cigarette smoke. I can always tell when items have been near a smoker. I can smell cigarette smoke the minute I open a box or bag sent by someone who smokes or someone whose household includes a smoker. And, as much as I LOVE my cat, animal hair is NOT something that we want to have on anything donated to a NICU or other hospital department. It may be necessary to wash finished items & roll with a lint roller before delivery. Also, be VERY CAREFUL to remove all straight pins from finished sewing projects. Use safety pins or yarn to attach labels—**not** straight pins!

I enjoy sharing photos with you—photos of newborns and photos of finished items that are ready for delivery. Thank you for sending photos of your work and for forwarding photos of newborns that you receive with thank you letters. When I receive thank you notes from parents, I reply with a request for a photo.

See above for a recent photo of me—taken in May 2013 at a friend's house. I do not photograph well and do not know how to smile for photos! But, this photo is reasonably decent. So, for those of you who have wondered who Bonnie Hagerman is and what she looks like, here I am!!!! I am 68 years of age, 5' 8" tall, and have hair color that ranges from "mud-gutter" blond to grey to white. I love to sew, but can knit simple items like hats. I made the blue & white stripe hat in the June 2013 issue. In September 2011 I retired after 42 years of employment. I am now enjoying the relaxed pace of retirement and the fun of having time to volunteer for Care Wear Volunteers. While working full-time, I had to squeeze in Care Wear Volunteers tasks wherever I could. Now, I usually go to the Care Wear Volunteers office each day and work from 10am to 3pm. However, I am taking a little more time for personal projects & outings. When friends call to invite me to join them for lunch, I go! When friends suggest outings for shopping or browsing, I go! So, I am sorry if I am not in the office when you call. Please leave a message. I will check messages when I return and call you back or send you what you request, etc. Please remember that Care Wear Volunteers has no secretary or any hired staff. This is a one-person volunteer office.

I didn't keep regular office hours during July because of construction on my office building. The good news is that there is a new standing-seam metal roof on the office. The bad news is that the noise of the portable generator & hammering on the roof were AWFUL! I stopped by the office almost every day, but left after completing essential paperwork and dealing with mail, e-mail, and telephone messages. When work on the roof ended, the same company began drilling out the old mortar all around the two-story brick building next door! The drilling noise & the noise of the generator were "brain-rattling." Soon, work will begin on replacing the missing front step into my office. After that, another company is contracted to totally renovate the front entrance (remove OLD storm door & framing that holds it, replace the rotted sill, refit the door, etc.). Slowly, but surely, the exterior is being improved.

Another note about my office hours. Sometime in September or October my husband and I may take a holiday. We are not sure of the destination right now (today is July 15), but if I don't answer my telephone or respond immediately to an e-mail, please understand that this is a one-person office. When I am not in the office, there is no one else!



2 The next newsletter will be the December issue. Until then, take care. *Bonnie (cont'd p.3)*

Continued from page 1:

Cassius arrived to cheers from his mother (Jess), his father (Oz), and his grandmother. Mom & Dad are pictured at right.



Justus for the Children
316 Soper Street
Morrisonville,
New York 12962

I received a telephone call from Dave Justus and learned that he is still working to provide assistance to families in need and especially children at Christmas. The economy in NY state has not recovered and many families are in need of assistance.

Please consider helping to provide toys, clothing, hats, sweaters, quilts, etc... for families at Christmas time. Dave also appreciates monetary donations to his 501(c)3 nonprofit effort.

Letter from Bonnie continued from p. 2:

P.S. Wishing everyone a wonderful fall and Thanksgiving with family and friends.

Building Update: The new roof was finished today (July 15th). This is a nice improvement to the exterior of the building.

Donations: Sincere thanks to everyone who sent donations to Care Wear Volunteers. Your donations are used to cover postage, printing, etc. Send to:



CARE WEAR VOLUNTEERS, Attn: Bonnie Hagerman
102 MERCER COURT #23-5, FREDERICK MD 21701
Make checks payable to: **Care Wear Volunteers**



VALLEY GRAPHIC SERVICE, INC.

93 Monocacy Blvd
Frederick, MD 21701

Sincere thanks to the management team of Valley Graphic Service, Inc. for their support for the community service efforts of Care Wear Volunteers. I needed new business cards with the address of the new office and Valley Graphic Service printed my new cards at no cost. Their thoughtfulness and excellent service are appreciated.

HEART 2 HEART
Red Heart Yarn Newsletter

In the May 2013 online newsletter from the Red Heart Yarn Company (Coats & Clark), Care Wear Volunteers was featured as the Community Service organization of the month. Clicking on the Care Wear Volunteers' logo brought readers to the new Care Wear Volunteers website. See the wonderful search features (for patterns in newsletters & hospitals). www.carewear.org

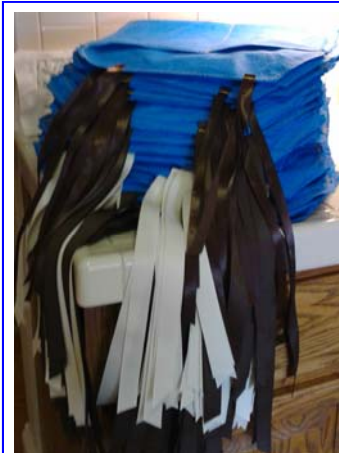

Kathy Schiek sent this photo of all of the walker caddies she completed and is ready to donate. That's a nice collection!!!!

Thanks to everyone who assembled already cut-out caddies.



Susan Avery sent this photo of the micro-preemie pouches, hats, and dress that she sent to Desert Regional Medical Center in Palm Springs, CA. Susan reported that Emanuel Hospital in Turlock, CA, no longer accepts donated layette items. I made that correction to the new website hospital listing.

Thanks to Susan for all that she does.



Dear Bonnie,
I recently received a request from a friend to make three crocheted blankets and hats for a baby shower she was having for a mother-to-be who will be delivering triplets soon. I told my friend that we don't sell our items but that I would be glad to ask some of our members to donate the baby items in return for a donation to Care Wear. I am attaching a picture of the mother-to-be opening her baby items. With the money we received for making the baby items, a donation from Ohio Spirited Hands will be sent to Care Wear this week. We were very happy to provide the blankets and hats for this happy mother-to-be.

Sincerely,
Carol Liepold
Ohio Spirited Hands
Dayton, Ohio



Phyllis Cross wrote & enclosed photos of items that she & her group delivered to their local hospital.
What a lovely collection!!!



Letters I enjoy receiving.....

Hi Bonnie,

I hope you remember me, Cindy Goodyear, I am trying to send a Care Wear package to every state in the union? Almost there, ran into some roadblocks but more on that later. I didn't know how you felt about finding other sewing patterns but I found the easiest ever baby hat pattern to sew. I have knit over 125 hats but since I am trying to wind this project up by the end of the summer I was looking for an easy pattern to sew. I just made 25 of these hats this afternoon. The hardest part was converting centimeters to inches but that's just me I guess. This is the site- <http://thebybeeblog.blogspot.com/search?q=baby+hat+to+sew>

I have five states left to complete my 50. The roadblocks I encountered were losing my job of 25 years, that kind of set me on my ear. Then my granddaughter's preschool needed superhero capes made, then another granddaughter needed finger puppets for her school, now kindergarten needed hand-painted memory shirts so I've been busy. Care Wear has always been on my mind though & now I can dedicate my time to completing this dedication to my late sister. It has been 5 years now since I started & I am invigorated again to complete the project. Of course I'll still make baby things for Care Wear, I love doing that. When I finish I will send you some of the letters I have received from hospitals, they are so nice to take time from their busy lives to sit down and, for the most part, write a handwritten letter. I have saved them all, along with a picture of a baby wrapped in one of my quilts I sent to Montana.

I hope to write again in September telling you it is complete. I love the new web page & I would love to visit the new headquarters of Care Wear sometime, the building is precious. My husband has just retired so who knows, a road trip may be in our future.

Back to sewing, life is good,
Cindy Goodyear



June 13, 2013

Dear Bonnie,

Hope all is well with you and all Care Wear Volunteers. At this end all is well.

I am almost back into my routine after attending High School and College graduations in North Carolina and Tennessee. After that we enjoyed a 4-day family reunion at Dale Hollow Lake in Kentucky. It was so wonderful that it is difficult to get back to a normal routine without having to pack & unpack.

Our May meeting went very well. Heartland Nursing Home was delighted to receive 13 caddies we made using the non woven fabric. Immediately they were put to good use. Elizabeth New Life Center could not stop thanking us for the baby items.

I am forwarding some photos taken during the meeting. See above for members of the group—including modeling chemo hats made by one of our volunteers. See some of the items collected during the meeting.

It is always fun to get together keeping in mind that we are making a difference.

Have a nice weekend!

Best regards, *Lydia*

The Rindge Congregational Church (Rindge, NH) held a *Make a Blanket Day* on May 4th from 10:00-4:00. The event was coordinated by Penny Chase with much help from various church members. We had 41 attendees making knitted, crocheted, quilted, and fleece blankets. Several church members made a wonderful lunch which was enjoyed by the blanket-making attendees. We collected 83 blankets & have had more coming in for a total of over 100 blankets. The blankets will be donated to area hospitals & shelters. A wonderful time was had by all. We hope this will be the first of many annual Project Linus *Make a Blanket Day* events. We are looking forward to our second annual Blanket Day next May! Everyone is welcome to join us!

Contact: Penny Chase, 645 N Central Street, Winchendon MA 01475

E-mail: pennyknitter@verizon.net



Note from Bonnie: It is a good idea to focus community service days on one item. That focus could be blankets or hats or shawls or lap blankets or an item requested by a local hospital or nursing home.

Hi--

Here are a couple pictures Wiebke sent of the baby wearing the layette items so you have a choice, I didn't have a choice, so am leaving it up to you ;-). She said if none were suitable, she'd try again. What a great in-law to have!!



Hope you are all settled in by now - what a neat office!!

Best,
Faith

PATTERNS in the **June 2013** Newsletter (p.12-13) and available on the Care Wear Volunteers website www.carewear.org



Bonnie, I wanted to share with you the first delivery to Forsyth NICU unit. We had a nephew born here last month who passed so this first round we did in both Care Wear & Jake's name. Eileen McClure donated a lot of the fabrics along with some from you. This delivery included 5 quilts, 30 preemie blankets, 10 positioning snakes, 10 burp pads, & 1 isolate cover made from the awesome dinosaur fabric you sent. It is quilted and we will see if they ask for more. I am working on more quilts for them using the other fabrics you sent too. Will forward pictures when we deliver. Take care & blessings....debbie pfaff



Bonnie,
Sending this picture of sewn, crocheted, & knitted items for the babies made by five Care Wear Volunteers who are members of the Titusville Space Coast Chapter of the American Sewing Guild. These items will be delivered to Janet this week.

Happy July 4th

Cindy Gooden



Cones of Yarn Available

If you are working on projects for adults (winter hats, shawls, etc..) and can use cones of wool or wool blend yarns, please call me to confirm my schedule so that we can arrange a mutually convenient time for you to stop by the office to pick up a cone or two. There are medium & heavy weights available—in brown, beige, green, & other dark colors. Medium weights can be combined to create worsted weight.

Postage is very expensive to mail these cones—sometimes more than it would cost to purchase equivalent yarn! Contact me if you live close to MD & are interested in having some of this yarn. I will check what it would cost to mail a cone or two.

**301-620-2858 or
carewear@comcast.net**



Natalie Van Kirk received a letter from The Department of Veteran Affairs, Medical Center, 7305 North Military Trail, West Palm Beach, FL 33410-6400 with their thanks for her delivery of handmade walker caddies. Natalie used donated blue nonwoven fabric from Frederick Memorial Hospital and mailed finished caddies to this Veterans Administration Hospital. Mary C. Phillips wrote, "...Once again, I would like to thank you for your compassionate interest in the Veterans' welfare & we are most grateful for this donation..."



Care Wear Volunteers received a thank you letter from Kathleen Bianchi (Marquette, MI) thanking participants for sending receiving blankets and baby caps. She wrote, "...They were darling and will be put to good use. A thought for next time—if there is a next time—is to use holiday themes. November—Orange, December—Red, Green, & White, February—Red & White, March—Kelly Green & white and Red, White, & Blue for Memorial Day & Fourth of July.

Kerriann Linville, Program Specialist, Healthy Start Coalition of Osceola County (407-891-9199) sent a letter of thanks to Marlys Martin for a box of beautiful handmade blankets.

She sent a second e-mail letter that she just received another box from Sharon I. Lipinski. 8 hats and 4 blankets. She wrote, "...You guys are awesome!"

Have a happy 4th of July! 7

DONATED KNITTING MACHINE

I have a donated knitting machine (with instruction booklet and some cones of yarn). The brand is BROTHER and I was told that it is in working order. This machine is HEAVY & so is the carton of supplies. Any local participant who wishes to have this machine to help make donated items, should contact me to arrange a mutually convenient time to come to my office.

301-620-2858 or carewear@comcast.net



U.S. Troops Drawstring Bag

National Quilting Day, March 15th, Service Project for OUR TROOPS.

Join in making Troop Bags. This is a national 501C3 non-profit charity that fills and sends the filled bags monthly to our troops. The request is for a 14" drawstring bag, it holds a filled gallon baggie. The troops can use the bags for personal use, and some pass them on to the children in Iraq.

When finished send to: **Operation Care Package**
611 Wilcox Street
Joliet, IL 60435

No special holiday or color is needed, everything goes. This is a great project for youth groups and those just starting to sew. Volunteers across the country will gather in their local communities to make the bags.

Fabric – 17" high x 30" wide

Drawstring cord – 1 yard

1 Cord Lock (optional)

1. Cut fabric 17" x 30".
2. Fold fabric **WRONG** sides together and sew for 2" along the side seam, back tack, leave a 1" space and continue to sew the length of the seam.

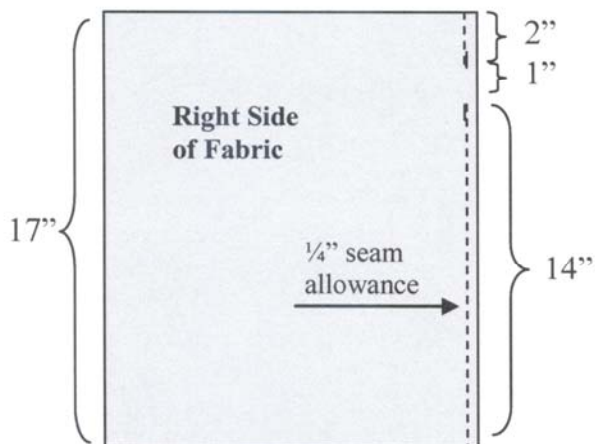

3. Press seam open and zig zag the seam allowance to the main fabric on both sides of the opening.

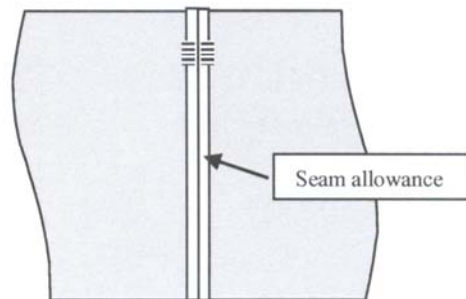

4. Turn bag with **RIGHT** sides together, press flat along seam line and stitch a 3/8" seam allowance over the 1/4" seam allowance. **Stop 2" down and leave a 1" opening.** Continue to finish sewing the side seam. This will make a "French seam" with all the raw edges encased.

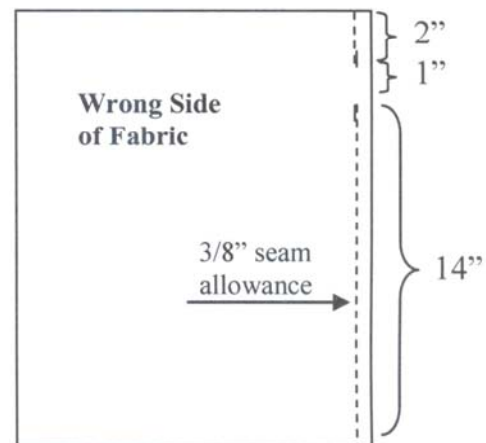

**FANTASY NATURALE
Knotted Baby Hat**



To Fit Size: Preemie, (Newborn, 3, 6, 12) months
Approx Circumference: 11 ¼", (12 ¾, 15 ½, 17, 18½)

Materials:

Fantasy Naturale:

1-100G skein, color 9702, Pink Yellow Orange Multi

Gauge: 17 sts= 4" in st st on size 8 needles.

Needles: US size 8 double points, stitch marker.

Pattern is written for smallest size, with larger sizes in parenthesis. If only one number is given, it applies to all sizes.

Begin

Cast on 48, (54, 66, 72, 78) sts and divide onto 3 double points. Join in the round, being careful not to twist. Place marker.

Round 1: knit

Round 2: purl

Repeat these 2 rounds for 3 times more. (8 rounds total).

Switch to st st (knit every round).

When hat measures 4 ½", (5, 5 ½, 6, 6 ½) from cast on edge.

Crown Shaping

Decrease Round 1: *k4, k2tog; rep from * around.
40, (45, 55, 60, 65) sts.

Decrease Round 2: knit all sts.

Decrease Round 3: *k3, k2tog; rep from * around.
32, (36, 44, 48, 52) sts.

Decrease Round 4: *k2, k2tog; rep from * around.
24, (27, 33, 36, 39) sts.

Decrease Round 5: *k1, k2tog; rep from * around.
16, (18, 22, 24, 26) sts.

Decrease Round 6: *k2tog; rep from * around.
8, (9, 11, 12, 13) sts.

Next Round: k across all sts, decreasing 0, (1, 1, 0, 1) st across. 8, (8, 10, 12, 12) sts.

Ties

Place half the sts onto one double point and half onto another. Working just on the 4, (4, 5, 6, 6) sts from one double point, work back and forth in garter stitch in rows for 1 ½". Bind off these sts.

Reattach yarn to the other 4, (4, 5, 6, 6) sts and work back and forth in in garter stitch in rows for 1 ½". Bind off these sts. Weave in all ends.

Tie the top ties into a knot.

Reprinted with written permission
June 24, 2013
Plymouth Yarn Company
www.plymouthyarn.com

THE ANTI-OUCH POUCH

by Deon Maas

This underarm hanging pillow is intended to add a little comfort to people's lives during a stressful, painful time. The pillow hangs from the shoulder, fitting snugly under the arm to cushion the underarm and breast area after breast surgery or during radiation treatment. Its wedge shape holds the arm slightly away from the body when the person is standing. The shoulder strap is adjustable. The fiberfill can be adjusted via an overlapped opening. The design is meant to look like a tote bag, and may be used on the right or left side of the body.



Supplies

Note: Directions are for 44"-45" wide fabric. **Seam allowances are 3/8".**

- 15" of 44"-45" wide soft fabric, preferably cotton (18" for larger woman)
- Two large handfuls of fiberfill
- 6" of hook-and-loop tape, such as Velcro

Cut

- Two 2 1/2" x 22" strips for straps
- One 12 1/2" x 44" section for pillow (for larger women, cut one 15 1/2" x 44" section)

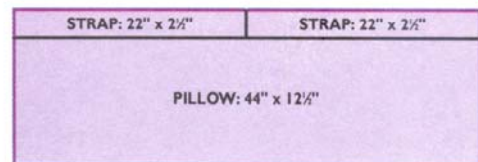

Straps

1. Fold each strap in half lengthwise, right sides together, creating a fold at one end.



2. Sew or serge both long sides of each strap.
3. Turn straps right side out and press.
4. Place the loop side of the hook-and-loop tape on one of the straps and the hook side on the other strap, each 1/4" from the folded end.

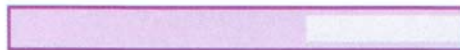

5. Stitch tape in place with either a straight or a zigzag stitch. If your machine skips stitches, try a larger needle.
6. Set straps aside.

Pillow

1. On the pillow section, make a double-fold hem at each end by pressing 1 1/2" of fabric to the wrong side. Press another 1 1/2" to the wrong side.

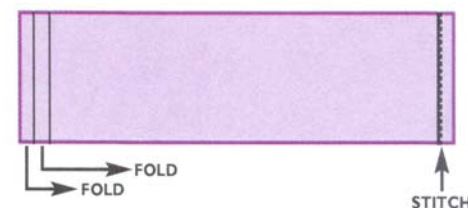

2. Stitch hem close to inside fold.
3. Place fabric *right side up*. Fold the hemmed ends inward, overlapping until each hemmed edge is approximately 2" from each folded edge.



4. Sew or serge each side.

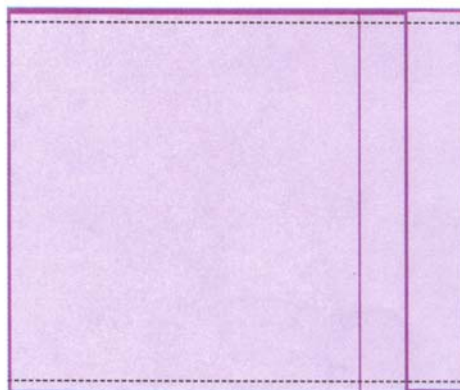

Note: Here comes the tricky part. You will now form the bottom edge of the pillow. *Continued on page 11*

Anti-Ouch Pouch

I received an e-mail from Marsha Ziegler sharing information about Anti-Ouch Pouches. The source is the American Sewing Guild (www.asg.org). Look for "Community Service" in the menu of option on that website.) Marsha wrote, "...A friend just had breast cancer surgery. She reported that she received a gift of an "antiouch pouch" which goes over the shoulder & relieves the pressure on the surgery areas. It can also be moved to the front to relieve pressure from seat belts. The amount of fill is adjustable also. It was a great benefit, my friend reported... Seemed like a good inclusion for the Care Wear Volunteers newsletter and future pattern book.' Here are the excellent directions from the American Sewing Guild.

5. Working on the end that is shown on the left in the previous illustration (the edge with the hemmed end sandwiched between the fabric), maneuver the seam so that the corner forms a triangle, with the seam in the center.

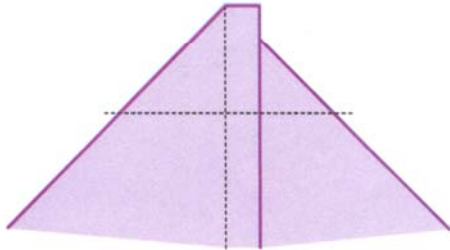

6. Stitch approximately 1/4" from point as shown. Make sure (by feel) that you do not "catch" the folded end that is sandwiched between the layers in this stitching.
7. Repeat for other corner of the same end.
8. Turn pillow right side out, gently poking out all four corners.

Attach the Straps

1. Place one strap on top of each long edge of the pillow with the raw edges 1/8" from the top edge. Make sure one strap has the hook-and-loop tape facing up and the other strap has the tape facing down.
2. Stitch each strap approximately 1/2"

from the top edge, through all the layers.

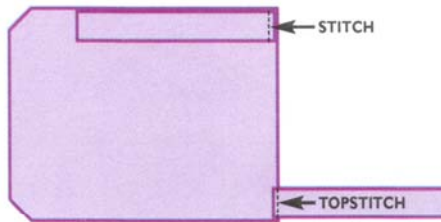

3. Flip straps forward and topstitch them near the top edge of pillow.

Stuff the Pillow

Please stuff the pillow *lightly* via the overlapped opening.

Note to the sewer: If you have used pins during any part of the sewing, please check that all are removed!

Deon Maas is a high school art teacher and a member of the ASG Central Illinois Chapter. She welcomes any comments or suggestions for refinement. Contact her at tommaas@winco.net.

© 2006 Deon Maas. These directions may be copied and distributed for non-profit use only.

Note: If you plan to make the Anti-Ouch Pouch as a community service project for a local hospital/breast care center, it's best to seek their approval before proceeding with the project.

www.asg.org

U.S. Troops Drawstring Bag Continued from page 8

5. Press seam to one side.
6. Turn bag **right sides out** (wrong sides together) and sew along the bottom seam with a 1/4" seam allowance.

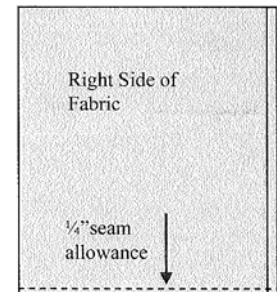

7. Turn bag **wrong side out** (right sides together) press the bottom seam flat and stitch across the bottom seam again with a 3/8" seam allowance. This will make another "French seam" encasing all the raw edges.

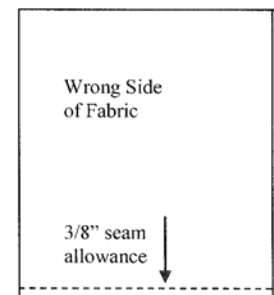

8. With bag still wrong sides out, fold down the top raw edges 2" and press.

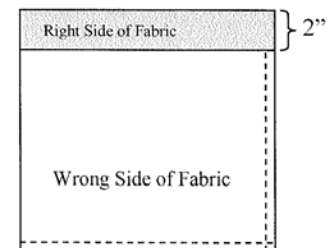

Continued on page 17

To explain the Anti-Ouch Pouch to its recipient, photocopy and sign this paragraph, then cut it out and paste it to a 3" x 5" index card.

This "Anti-Ouch Pouch" was designed by Deon Maas and is dedicated to her mother, Doris Lock, who taught her to sew. Both women are breast cancer survivors and members of the American Sewing Guild. This soft pillow is designed to be worn snugly against the underarm area to cushion the area after breast surgery. The wedge shape gently holds the arm away from the body when the user is standing. The strap holds the pillow in place without having to use sore arm muscles to "clutch" it. The strap is adjustable and the fiberfill may be adjusted via the overlapped opening. This pillow was made by:



Sending sincere apologies for errors in this pattern in the DECEMBER 2012 newsletter (pp. 16-17).



CORRECTED VERSION

BURIAL SACQUE FOR PREEMIE BABY 1-2 pounds

Materials: Bernat Softee Baby (1 ball).
Needles: Size 6.
Ribbon: 1/8" wide.
Gauge: 6 sts. = 1", approx.

Cast on 30 sts.

Row 1: K.1, *inc. in next stitch, K.1 Repeat from * to end of row, K.2.

Row 2: Purl.

Row 3: K.1.,inc. in next st., K2. Repeat to end of row, K.1. (58 sts.)

Begin pattern:

| | |
|---------------|--|
| Row 1: | Purl |
| Row 2: | K1, *P2, K1. Repeat from * to end of row. |
| Row 3: | Purl. |
| Row 4: | Knit. |

Repeat pattern until work measures approx. 2 inches.

Keeping pattern as established, cast on 3 sts. at the beg. of the next 2 rows (64 stitches).

Continue in pattern, keeping the first and last 3 stitches in garter stitch until work measures about 11" from the beginning, ending with Row 4.

Next row: Bind off 3 stitches,* P2.tog., P1 repeat from * to last 3 sts., K.3.

Next row: Bind off 3 stitches, knit to end. (39 stitches)

Next 8 rows: Knit in garter stitch.

Next row: K1. *inc, in every stitch to last stitch, K.1.

Bind off.

Sew front seam up to the cast on stitches.

Cut 5 pieces of ribbon into equal lengths (long enough to tie a bow). Dividing equally up front of the sacque, insert a ribbon into 3rd stitch of the border (right or left) and tie a knot. Thread the other end of the ribbon to match on the other side of the border. Draw together to close the opening of the sacque and make a bow.

Sew up bottom seam.

In case of questions, please contact
Heather.Rinkel@yahoo.com or 567 Brenna Trail, East
Jordan, MI 49727.

PREEMIE CAP TO MATCH PREEMIE BURIAL SACQUE

Materials: **Bernat Softee Baby**
 Size 4 needles

Cast on 36 stitches, work in garter stitch for 6 rows.

Begin pattern:

Row 1: Knit
Row 2: Purl
Row 3: K.1, *Purl 2, K1, repeat to end
Row 4: Purl.

Repeat pattern until work measures 3-1/2" from cast on.

Shape top:

Row 1: K2.tog. to end of row.
Row 2: Purl.
Row 3: K2.tog. to end of row.
Row 4: Purl.

Leave a long thread, draw remaining stitches together and fasten off. Sew up back seam.

Easy to convert to 4 needles:

Garter stitch: knit 1 round, purl 1 round until 4 ridges.

Pattern: Rows 1, 2 and 4: Knit
 Row 3: As Pattern Row 3 above.

NO CHANGES to this hat pattern (also found in the December 2012 Newsletter).

PHOTO on page 12

Here is a list of ways to help.

You can write letters. You can send hand knit or crochet scarves, beanie babies, old cell phones, ink-jet cartridges, Easter & Halloween candy, Girl Scout Cookies, etc... See their website for details or call their information line.



Operation Gratitude is the 501 (c)(3), non-profit, volunteer organization that sends care packages of items and letters addressed to Wounded Warriors & U.S. Service Members deployed in combat.

Our mission: Put a smile on a Service Member's face and express America's support.

Web: www.OperationGratitude.com FB: www.facebook.com/OperationGratitude
Email: OpGrat@gmail.com Info Line: 818.909.0039



LW3631



crochet

Designed by Sharon Mann

What you will need:

RED HEART® Soft Baby Steps®:
1 ball each 9600 White A and
9600 Baby Blue B

Susan Bates® Crochet Hook:
3.75mm [US F-5]

12mm button, stitch marker, yarn
needle

GAUGE: 16 sts = 4" [10 cm]; 10
rows = 5" [12.5 cm] in single
crochet. **CHECK YOUR GAUGE.** Use
any size hook to obtain the gauge.



**RED HEART® Soft
Baby Steps®,**
Art. E746 available in
solid color 5 oz (141 g), 256 yd
(234 m); prints 4 oz (113 g), 204 yd
(187 m) balls



I'm the Prince Bib

*Crochet this dressy dinner bib with elegant
crown appliqué. Baby will look precious and
mommy will love that it is easily washed.*

Bib measures 10½" [26.5 cm] at widest
point x 11" [28 cm] at longest point

SPECIAL ABBREVIATIONS

sc2tog: [Draw up a loop in next st] twice, yarn
over and draw through all 3 loops on hook.
dc2tog: [Yarn over, insert hook in next stitch,
yarn over and pull up loop, yarn over, draw
through 2 loops] 2 times, yarn over, draw
through all loops on hook
Dc3tog: [Yarn over, insert hook in next stitch,
yarn over and pull up loop, yarn over, draw
through 2 loops] 3 times, yarn over, draw
through all loops on hook

BIB

Star Center

With A, ch 4, slip st in beginning ch to form ring.

Round 1: Ch 3 (counts as dc here and
throughout), dc in ring, *ch 1, 2 dc in ring;
repeat from * 4 more times, ch 1, slip st in top
of ch 3 – 18 sts.

Round 2: Ch 3, dc in next st, *(dc, ch 1, dc)
in ch-1 space, dc in next 2 sts; repeat from *
around, (dc, ch 1, dc) in last ch-1 space, slip st
in top of ch 3 – 30 sts. Fasten off.

Round 3: Join A in any ch-1 space, ch 4
(counts as dc and ch 1 here and throughout),
dc in same space, *dc in each dc to next
ch-1 space, (dc, ch 1, dc) in next ch-1 space;
repeat from * 4 more times, dc in each dc to
first st, slip st in 3rd of ch-4 – 42 sts.
Rounds 4-6: Slip st in ch-1 space, ch 4, dc
in same space, *dc in each dc to next ch-1
space, (dc, ch 1, dc) in next ch-1 space; repeat
from * 4 more times, dc in each dc to first st,
slip st in 3rd of ch 4 – 78 sts on last round.
Fasten off.

Shape Star Points

First Point
Row 1: With right side facing, join A in any dc
after a ch-1 space, ch 3, dc in the next 11 sts,

leave remaining sts unworked – 12 sts.
Row 2: Ch 1, turn, sc in first st, sc2tog, sc
across to last 3 sts, sc2tog, sc in top of ch
3 – 10 sts.

Row 3: Ch 3, turn, dc in each st across.

Rows 4-5: Repeat Rows 2-3 – 8 sts.

Row 6: Repeat Row 2 – 6 sts.

Row 7: Ch 3, turn, [dc2tog] twice, dc in last
st – 4 sts. Fasten off.

Shape Points 2-4

Join yarn in next ch-1 space and work as for
First Point.

Shape Right Neck Strap

Row 1: With right side facing, skip 3 sts to
left of center unworked ch-1 space, join yarn
in next st, ch 3, dc in next 8 sts, 2 dc in next
ch-1 space – 10 sts.

Row 2: Ch 1, turn, sc in each st across.

Row 3: Ch 3, turn, dc in each st to last 2 sts,
dc2tog – 9 sts.

Row 4: Ch 1, turn, sc in each st to last st, 2 sc
in last st – 10 sts.

Row 5: Repeat Row 3.

Row 6: Ch 1, turn, sc2tog, sc in each st to last
st, 2 sc in last st – 9 sts.

Row 7: Ch 3, turn, dc in next 4 sts, [dc2tog]
twice – 7 sts.

Row 8: Ch 1, turn, sc2tog, sc in each st
across, ch 14.

Row 9: Dc in 4th ch from hook, dc in next 10 ch,
dc in next 3 sts, hdc in next st, sc2tog – 17 sts.
Fasten off.

Shape Left Neck Strap

Row 1: With right side facing, join A in next
ch-1 space to right of center unworked ch-1
space, ch 3, dc in next 9 sts – 10 sts.

Row 2: Ch 1, turn, sc in each st across – 10 sts.

Row 3: Ch 3, turn, dc2tog, dc in each st across
– 9 sts.

Continued...

Continued on page 15

Please Note: Print this pattern using Landscape Orientation.

Find more ideas & inspiration: www.redheart.com and www.crochetoday.com

©2013 Coats & Clark

Row 4: Ch 1, turn, 2 sc in first st, sc in each st across – 10 sts.

Row 5: Repeat Row 3.

Row 6: Ch 1, turn, 2 sc in first st, sc in each st to last 2 sts, sc2tog – 9 sts.

Row 7: Ch 3, turn, [dc2tog] twice, dc in each st across – 7 sts.

Row 8: Ch 1, turn, sc in in each st to last 2 sts, sc2tog. Fasten off.

Row 9: With right side facing, join **A** in first st of Row 8, ch 13. Fasten off.

Join **A** in last st of Row 8, sc2tog, hdc in next st, dc in next 3 sts, dc in remaining 13 ch – 17 sts. Fasten off.

CROWN

With **B**, ch 13.

Row 1: Sc in 2nd ch from hook, sc in each ch across – 12 sts.

Row 2: Ch 3 (counts as dc here and throughout), turn, dc in next st, *ch 1, skip next st, dc in next st; repeat from * across.

Row 3: Ch 1, turn, sc in each st across – 12 sts.

Row 4: Ch 2 (counts as hdc here and throughout), turn, hdc in first st, dc3tog all in next st, hdc in next st, [dc3tog all in next st] 3 times, hdc in next st, dc3tog all in next st, hdc in next st, dc3tog all in next st, hdc in last st.

Row 5: Ch 6, turn, skip 2 sts, sc in next st, ch 8, skip 2 sts, sc in next st, ch 8, skip 2 sts, sc in next st, ch 6, sc in last st.

Fasten off.

Row 6: Join **B** in last st of Row 5, ch 1, work 6 sc in ch-6 space, [work 8 sc in next ch-8 space] twice, 6 sc in next ch-6 space, slip st in first st of Row 5.

Fasten off.

Row 7: Join **B** in space in between ch-8 spaces on Row 5, (ch 3, dc3tog, ch 3, slip st) all in same st.

Fasten off.



Please Note: Print this pattern using Landscape Orientation.

Find more ideas & inspiration: www.redheart.com and www.crochettoday.com

©2013 Coats & Clark

FINISHING

Sew Crown in center of Bib.

Bib Edging

With right side facing, join **A** in top of Right Neck Strap, sc evenly spaced around outside and neck edges of Bib, ch 3 for button loop, slip st in first st.

Sew button opposite button loop on Left Neck Strap.

Weave in ends

Abbreviations

A, B, C = Color A, B, C; **ch** = chain; **dc** = double crochet; **hdc** = half double crochet; **mm** = millimeters; **sc** = single crochet; **st(s)** = stitch(es); **tog** = together; **yo** = yarn over; **[]** = work directions in brackets the number of times specified; ***** or ****** = repeat whatever follows the * or ** as indicated.

PINK for Princesses!



HOSPITAL UPDATES

Sylvia Beamer of Randolph Hospital wrote (May 20th) that they had a good supply of IV covers, but they were in need of BLANKETS and SHAWLS.

Sylvia Beamer
Volunteer Services
Randolph Hospital
PO Box 1048
Asheboro NC 27204
336-629-8886

Emerson Hospital
Concord, MA

New contact person is JANET DAVIS, Volunteer Manager. She replaced Sharon Knox.

jadavis@emersonhos.org

Hope Children's
Hospital
Oak Lawn, IL

New contact person:
Lisa Boland
(Lisa.boland@advocatehealth.com) replacing Claire Winer.

NEW HOSPITAL

Meadowlands Hospital
Attn: Nursing Staff-
Labor & Delivery
55 Meadowlands Pkwy
Secaucus NJ 07094

Requests burial garments

The Hints from Heloise column (June 27, 2013) included this information for helping others by donating your old eyeglasses. Contact your local Lion's Club or mail to: Lions Club International Headquarters, Attn: Receiving Dept., 300 West 22nd Street, Oak Brook, IL 60523
OR mail to:

New Eyes for the Needy, 549 Millburn Avenue, PO Box 332, Short Hills, NJ 07078





LW3657



knitting

Designed by Lisa Gentry

What you will need:

Red Heart® Soft Baby Steps®
4 balls 9800 Baby Blue OR 9700
Baby Pink.

Susan Bates® Circular Knitting
Needles: 5mm [US 8] – 36"
(91.4 cm)

Yarn needle

GAUGE: 14 sts = 3" (7.6 cm);
21 rows = 4" (10 cm) in pattern.
CHECK YOUR GAUGE. Use any
size needle to obtain the gauge.

Buy Yarn



RED HEART® Soft
Baby Steps® Art. E746
available in solid color

5 oz (141 g), 256 yd (234 m); prints
4 oz (113 g), 204 yd (187 m) balls



Prince or Princess Blanket

Knit a beautiful blanket in cuddly soft yarn for a new precious baby boy or girl. This pattern is timeless, elegant and perfect for your dear little one.

Blanket measures 35" x 38" (89 x 96.5 cm)

SPECIAL ABBREVIATION

Loop = [Move st on right needle back to left needle, K1] two times.

BLANKET

Cast on 121 sts.

Row 1 (Right Side): K8; [P7, K7] eight times; K1.

Row 2: P8; [K7, P7] eight times; P1.

Row 3: K4, yo, K2tog, K2; [P3, yo, P2tog, P2, K3, yo, K2tog, K2] eight times; K1.

Row 4: Repeat Row 2.

Row 5: K2, K2tog, yo, K1, yo, K2tog, K1; [P1, P2tog, yo, P1, yo, P2tog, P1, K1, K2tog, yo, K1, yo, K2tog, K1] eight times; K1.

Row 6: Repeat Row 2.

Row 7: K3, K2tog, yo, K3; [P2, P2tog, yo, P3, K2, K2tog, yo, K3] eight times; K1.

Row 8: Repeat Row 2.

Repeat Rows 2–8 eighteen more times.

Last Row: K8; [P7, K7] eight times; K1.

Bind off all sts.

Shell Edging

Row 1 (Right Side): Beginning at bound-off edge, * [pick up and K6 sts across next square] 19 times; continuing along next side [pick up and K6 sts across next square] 16 times; pick up and K5 sts across next square; repeat from * one more time – 430 sts; place marker for beginning of row.

Row 2: Purl.

Row 3: K1: *work 5 sts in next st; turn; P5, slip next st, turn; K2tog; [Loop, K1, pass first stitch on needle over next st] three times; Loop, K2tog, pass first stitch on needle over next st; bind off 3 sts; repeat from * to end. Fasten off. Weave in ends.

ABBREVIATIONS

K = knit; K2tog = knit two together; mm = millimeters; P = purl; P2tog = purl two together; st(s) = stitch(es); yo = yarn over; * or ** = repeat whatever follows the * or ** as indicated; [] = work directions in brackets the number of times specified.

See chart on next page.



Please Note: Print this pattern using Landscape Orientation.

Find more ideas & inspiration: www.redheart.com and www.crochettoday.com

©2013 Coats & Clark

RedHeart.com

Continued on page 17

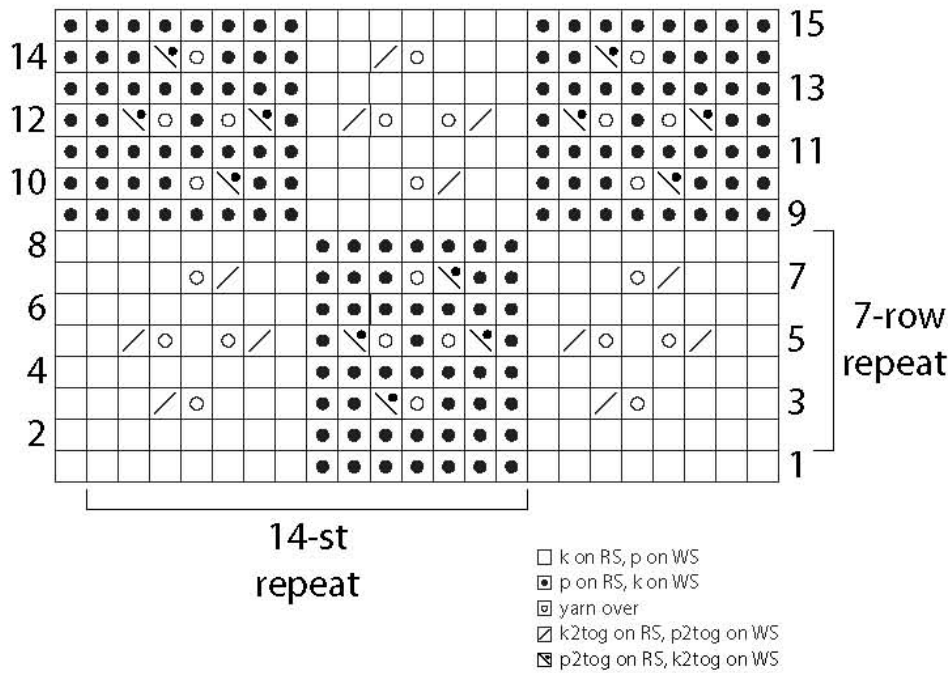

U.S. Troops Drawstring Bag
Continued from page 11

9. Fold raw edges under again to meet the pressed edge forming a one inch casing, press and pin in place.

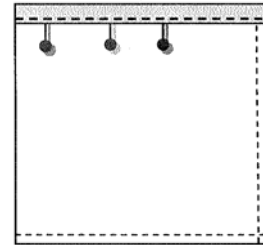

10. Stitch around the entire top edge of the bag very close to the folded edge, making a 1" drawstring casing.
11. Turn bag right side out.
12. Attach a safety pin in the drawstring and place it through the opening that was created in the side seam of the casing. Pull the string all the way around the casing exiting where you started.
13. Thread both ends of the drawstring through the opening of the optional cord lock, and/or tie the cords together at the ends.

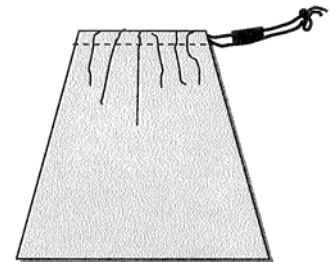

Note: If you wish to you can send a "general" letter for our troops inside your bag and it will be sent along with the filled baggie. An empty gallon baggie would also be helpful.

© 2008 The Creative Thimble
Laura Martell
From "Community Service" on the website of The American Sewing Guild (www.asg.org)



Heather Rinkel sent this photograph of the latest endeavors of 2 members of her group (there's only 3!)— burial gowns, sacques, hats, & booties. Gaye & Carol made all of the items pictured above. This is in addition to the box Heather mailed out on Monday that she did not photograph. **BRAVO to this wonderful group!!!!**





LW3637



crochet

Designed by Nancy Anderson

What you will need:

RED HEART® Soft Baby Steps®.
1 ball each 9600 White A, 9700 Baby Pink OR 9800 Baby Blue B

Susan Bates® Crochet Hook:
4mm [US G-6]

Stitch marker, yarn needle

GAUGE: 20 sts = 4" [10 cm] in single crochet. **CHECK YOUR GAUGE.** Use any size hook to obtain the gauge.

Buy Yarn



RED HEART® Soft Baby Steps®, Art. E746 available in solid color
5 oz (141 g), 256 yd (234 m); prints
4 oz (113 g), 204 yd (187 m) balls



Crown Booties

Slip those cute little toes into these precious crown embroidered booties. We show them in both pink and blue, but any color can be used to embroider the royal crown motif.

Bootie measures 4½" [11.5cm] long x 2" [5cm] wide

SPECIAL ABBREVIATIONS

sc2tog: [insert hook in next st, yarn over, draw yarn through st] twice, yarn over, draw yarn through 3 loops on hook.

BOOTIES

Sole

With B, ch 13.

Round 1: Sc in 2nd ch from hook and in next 10 ch, 3 sc in last ch, turn to work along opposite edge of foundation ch, sc in 10 ch, 3 sc in last ch, slip st in first sc to join – 27 sc. Place marker for beginning of round.

Round 2: Ch 1, 2 sc in same st, *sc in next 10 sc, 2 sc in next 3 sts; repeat from * once more, slip st in first sc – 34 sc.

Round 3: Ch 1, 2 sc in same st, 2 sc in next st, sc in next 9 sts, hdc in next 2 sts, 2 hdc in next 5 sts, hdc in next 2 sts, sc in next 9 sts, 2 sc in next 2 sts, sc in next 3 sts, slip st in first sc – 43 sts.

Round 4: Ch 1, 2 sc in same st, 2 sc in next 2 sts, sc in next 11 sts, hdc in next 3 sts, [2 hdc in next st, hdc in next 3 sts] twice, sc in next 13 sts, 2 sc in next 2 sts, sc in next 3 sts, slip st in first sc – 50 sts.

Round 5: Ch 2 (counts as hdc here and throughout), working in back loops only, hdc in each st around, slip st in top of beginning ch. Fasten off.

Bootie Upper

Round 1: Join A in same st as joining, ch 1, working in back loops only, sc in each st around to last 2 sts, sc2tog – 49 sts.

Rounds 2-3: Ch 1, sc in each sc around, slip st in first sc. Fasten off.

Shape Ankle

Row 1: Skip first 34 sc of last round, join A in next sc, ch 1, sc in same sc, hdc in next 26 sc, sc in next sc – 28 sts.

Row 2: Ch 1, turn, sc2tog, sc in next 6 sts, [sc2tog] twice, sc in next 4 sts, [sc2tog] twice, sc in next 6 sts, sc2tog – 22 sts. Fasten off.

Shape Toe

Row 1: Skip next 7 sts of last complete round of Bootie Upper, join A in next st, ch 1, sc in same st, sc in next 6 sc – 7 sc.

Row 2: Ch 1, turn, sc in each sc, sc in next skipped sc along complete round – 8 sc.

Row 3: Ch 1, turn, sc in each 8 sc, sc in next skipped sc along complete round – 9 sc.

Rows 4-8: Ch 1, turn, sc in each sc.

Row 9: Ch 1, turn, sc2tog, sc in each sc to last 2 sc, sc2tog – 7 sts. Fasten off.

Finishing

Following Crown Chart and using B, embroider Crown in center of Toe in cross stitch.

Sew edges of Toe and Ankle pieces together. Weave in ends.

Abbreviations

A, B, C = Color A, B, C; ch = chain; hdc = half double crochet; mm = millimeters; sc = single crochet; st(s) = stitch(es); [] = work directions in brackets the number of times specified; * or ** = repeat whatever follows the * or ** as indicated.

See chart on next page.



Please Note: Print this pattern using Landscape Orientation.

Find more ideas & inspiration: www.redheart.com and www.crochettoday.com

©2013 Coats & Clark

RedHeart.com

LW3637 Crown Booties

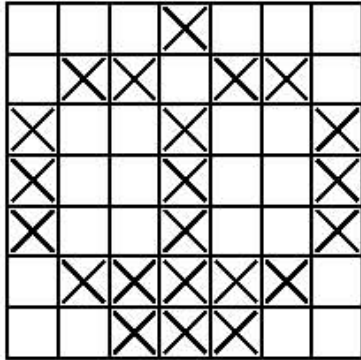

Please Note: Print this pattern using Landscape Orientation.

Find more ideas & inspiration: www.redheart.com and www.crochettoday.com

©2013 Coats & Clark

EPISCOPAL



CHURCH

St. Ann's Church for the Deaf

209 East 16th Street; New York, New York 10003 (347) 458-9571 or (646) 807-4019

May 30, 2013

Care Wear Volunteers Inc.
Bonnie Hagerman
102 Mercer Court Suite #23-5
Frederick, MD 21701

Dear Ms. Hagerman,

We wish to thank you for the variety of yarn that was provided by your organization to St. Ann's Church for the Deaf. Our congregants used the yarn to crochet baby hats, blankets, shoes and jackets which were donated to newborn babies at Beth Israel Medical Center's maternity ward on 16th Street and 1st Avenue in New York City.

It was a wonderful experience for our deaf congregants to witness first-hand the pleasure of interacting with the mothers and babies as they donated their beautiful gifts. Likewise, the mothers were pleasantly surprised and expressed disbelief that the gifts were handmade and given to their babies.

We have attached some pictures of the crocheted baby clothing and photos of the mothers with their babies as they received their gifts on that unforgettable day of December 13, 2012. It was a day that was cherished by us and our congregants, some of whom had never crocheted before. Thank you for donating the yarn as it gave us the opportunity to participate in this new and treasured experience.

Yours truly,

Evelyn Schafer and Melissa Inniss,
Lay Leaders of St. Ann's Church for the Deaf

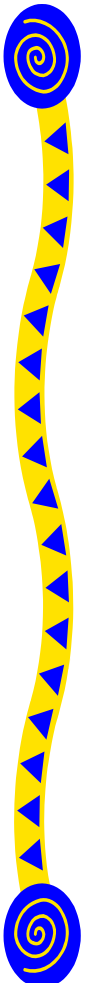
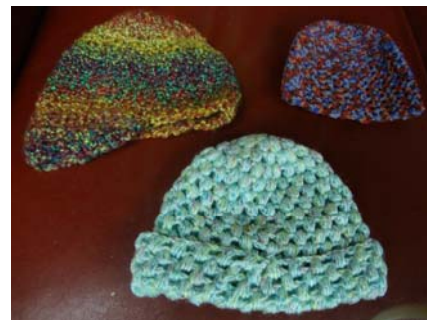



LW3474



knitting

Designed by Julie Farmer

What you will need:

RED HEART® Anne Geddes™:
1 ball 623 Spearmint A and 1 ball 100 Lily B.

Susan Bates® Knitting Needles:
4 mm [US 6] circular, 16" (40 cm) long; and 4 mm [US 6] double pointed needles

Stitch markers, yarn needle, pom-pom maker

GAUGE: 18 sts = 4" (10 cm); 26 rows = 4" (10 cm) in Stockinette stitch (knit on right side, purl on wrong side). **CHECK YOUR GAUGE.** Use any size needles to obtain the gauge.



RED HEART® Anne Geddes™, Art. 805
available in solid 3.5 oz (100 g), 340 yd (310 m) and multi 3.5 oz (100 g), 290 yd (265 m)



Cottontail Bunny Cocoon & Hat

That little cutie that has jumped right into your heart will look picture-perfect in this cozy cocoon with matching bunny-eared hat. Knit in soft yarn baby will likely be comfy and happy during a photo opportunity.

Cocoon measures 20" (51 cm) circumference and 18" (45.5 cm) long

Finished Hat Size: 14 (18)" (35.5 (45.5) cm) head circumference

Hat directions are written for size Small/Medium (Baby's) with changes for size Medium/Large (Toddler's) in parentheses

Special Stitch

ssk = Slip next 2 stitches, one at a time as if to knit, to right needle, insert point of left needle through front of sts, knit these sts together through back loop.

COCOON

Beginning at top edge with circular needle and A, cast on 90 sts. Place marker for beginning of round. Taking care not to twist stitches, join to work in rounds.

Work in Stockinette st worked in rounds (knit every round) until piece measures 16" (40.5 cm) from beginning (do not unroll beginning of piece to measure).

Shape Bottom

Round 1: *K8, k2tog; repeat from * around—81 sts.

Round 2 and all even-numbered rounds: Knit. Change to double pointed needles as you work the next round.

Round 3: *K7, k2tog; repeat from * around—72 sts.

Round 5: *K6, k2tog; repeat from * around—63 sts.

Round 7: *K5, k2tog; repeat from * around—54 sts.

Round 9: *K4, k2tog; repeat from * around—45 sts.

Round 11: *K3, k2tog; repeat from * around—36 sts.

Round 13: *K2, k2tog; repeat from * around—27 sts.

Round 15: *K1, k2tog; repeat from * around—18 sts.

Round 17: *K2tog; repeat from * around—9 sts. Cut yarn leaving a 12" (30.5 cm) tail. Weave tail through remaining stitches, pull to gather and close opening. Secure tail and weave in.

HAT

Beginning at lower edge with double pointed needles and A, cast on 64 (80) sts. Place marker for beginning of round. Taking care not to twist stitches, join to work in rounds.

Work in Stockinette st worked in rounds until piece measures 4 (5)" (10 (12.5) cm) from beginning (do not unroll beginning of piece to measure).

Shape Crown (top of hat)

Round 1: *K6, k2tog; repeat from * around—56 (70) sts.

Round 2 and all even-numbered rounds: Knit. Round 3: *K5, k2tog; repeat from * around—48 (60) sts.

Round 5: *K4, k2tog; repeat from * around—40 (50) sts.

Round 7: *K3, k2tog; repeat from * around—32 (40) sts.

Round 9: *K2, k2tog; repeat from * around—24 (30) sts.

Round 11: *K1, k2tog; repeat from * around—16 (20) sts.

Round 13: *K2tog; repeat from * around—8 (10) sts.

Cut yarn leaving a 12" (30.5 cm) tail. Weave tail through remaining stitches, pull to gather and close opening. Secure tail and weave in.

Continued...



Ears

Back of Ear (make 2)

With circular needle or two double pointed needles and **A**, cast on 10 sts.
Work in Stockinette st worked in rows (knit on right side, purl on wrong side) until piece measures 3" (7.5 cm) from beginning, end with a wrong side row.

Decrease Row (right side): Ssk, knit to last 2 sts, k2tog—8 sts.

Next Row: Purl.

Repeat last 2 rows twice—4 sts.

Next Row: Ssk, k2tog—2 sts.

Next Row: Purl.

Next Row: K2tog.

Fasten off.

Front of Ear (make 2)

With circular needle or two double pointed needles and **B**, cast on 7 sts.
Work in Stockinette st worked in rows until piece measures 3" (7.5 cm) from beginning, end with a wrong side row.

Decrease Row (right side): Ssk, knit to last 2 sts, k2tog—5 sts.

Next Row: Purl.

Repeat last 2 rows—3 sts.

Next Row: Ssk, k1—2 sts.

Next Row: K2tog.

Fasten off.

FINISHING

Hold right sides of one front of ear and one back of ear together. Sew edges of pieces together. Turn ear right side out. Repeat for second front and back of ear. Gather bottom of ears and sew to hat.

With **B**, make a 2½" (6.5 cm) pompom and sew to lower back of cocoon.

Weave in any remaining ends.

ABBREVIATIONS

A, B = Color A, Color B etc; **k** = knit;
k2tog = knit next 2 sts together; **p** = purl;
p2tog = purl next 2 sts together; **st(s)** = stitch(es); * = repeat whatever follows the * as indicated.



Please Note: Print this pattern using Landscape Orientation.

Find more ideas & inspiration: www.redheart.com and www.crochettoday.com

©2013 Coats & Clark



LAP BLANKETS FOR VETERANS

I have a letter that "...lap blankets for veterans are in desperate need. If your organization can help with that, we would be so grateful..."

The Lake City VA Medical Center (VAMC), Attn: Melanie Adams, Assistant Chief, Voluntary Service, 619 S. Marion Ave, Lake City, FL 32025

386-755-3016 x-2032
Melanie.Adams1@va.gov

Melanie suggested 36" x 48" lap blankets in a variety of colors & materials (lighter fabrics for summer & heavier fabrics for winter).

See page 29 for more information about lap blankets for veterans.

Natalie Van Kirk mailed walker caddies to this VA Medical Center. You might contact Melanie to see if more are needed.

Shannon Harrington, Family Birthing Center & NICU Social Worker, Women's & Children's Center, 580 West College Ave, Marquette, MI 49855 wrote to thank you for donations sent/delivered to that hospital. She wrote, "...Thank you so much for supporting our NICU families with your beautiful handmade items. Families love them & I love giving them out..."

Knitting Resource recommended by the girls in the Laramie WY Girl Scouts.

Knitting 101 A Beginner's Resource Guide

http://www.paradisefibers.com/knitting_101_beginners_resource_guide



T-strap Booties

These cute booties are perfect for the princess baby. Crocheted with a T-strap and a cute button, her ensemble will be complete.

LW2963



Designed by Nazanin S. Fard.

Directions for size Newborn-3 months; changes for size 6 months are in parentheses.

Booties measure 4" (4½") along length of foot.

Red Heart® Baby Sheen™: 1 skein 0700 Pink.

Crochet Hook: 3.5mm [US E-4].

2 Pink ½" (13 mm) buttons with shank, sewing needle and matching thread, Yarn needle.

GAUGE: 5 dc = 1". **CHECK YOUR GAUGE.** Use any size hook to obtain gauge.

SPECIAL ABBREVIATIONS

Back Post Half Double Crochet (BPhdc) = Yo, insert hook from back to front to back again, around post of indicated st, yo and draw up a loop, yo and draw through 3 loops on hook.

Half Double Crochet Decrease (hdc2tog) = [Yo, insert hook into next st, yo and draw up a loop] twice, yo and draw through all 5 loops on hook.

RIGHT BOOTIE

Ch 15 (17).

Round 1: 2 hdc in third ch from hook; hdc in each of next 11 (13) chs, 3 hdc in last ch; working on the opposite side of the same chs, hdc in each of next 11 (13) chs; sl st into the second ch – 28 (32) hdc.

Round 2: Ch 2 (count as hdc), hdc in same sp; 2 hdc in each of next 2 hdc, dc in each of next 11 (13) hdc, 2 hdc in each of next 3 hdc, dc in each of next 11 (13) hdc; sl st into the second ch – 34 (38) sts.

Round 3: Ch 2 (count as hdc), hdc in same sp; 2 hdc in each of next 5 hdc, dc in each of next 11 (13) dc, 2 hdc in each of next 6 hdc, dc in each of next 11 (13) dc; sl st into the second ch – 46 (50) sts.

Round 4: BPhdc in each st around. Do not join – 46 (50) hdc.

Rounds 5-6: Hdc in every hdc around.

Round 7: Hdc in each of the next 21 (23) hdc, 7 hdc2tog in next 14 hdc, hdc in each of the next 11 (13) hdc.

Round 8: Hdc in each of next 21 (23) hdc, 4 hdc2tog in next 8 hdc decreases, hdc in next 9 (11) hdc. Fasten off.

T-strap

Attach yarn to the center front st; ch 5.

Row 1: Sc in second ch from hook, sc in each of next 3 chs, slip st into the same st as the attachment – 4 sc. Fasten off.

Strap

Row 1: Starting from the T-strap, skip next 7 (9) sts; attach yarn to next st, ch 2, hdc in next 19 (21) sts, ch 6; sc in the side of each of next 2 sts at the top of the T-strap, ch 12; turn – 40 (42) sts.

Row 2: Skip next 6 ch for buttonhole loop; sc in next 32 (34) sts. Fasten off.

LEFT BOOTIE

Work same as Right Bootie. Work Strap as follows:

Row 1: With wrong side facing and starting from the T-strap, skip next 7 (9) sts; attach yarn to next st, ch 2, hdc in next 19 (21) sts, ch 6, sc in the side of each of next 2 sts at the top of the T-strap, ch 12; turn – 40 (42) sts.

Row 2: Skip next 6 ch for buttonhole loop; sc in next 32 (34) sts. Fasten off.

Sew button at the edge of ankle of the bootie.

Weave in ends.



Red Heart® Baby Sheen™, Art E795 available in solid color 3.5 oz (100 g), 307 yd (281 m) and multicolor 3 oz (85 g), 261 yd (239 m).

ABBREVIATIONS: ch = chain; dc = double crochet; hdc = half double crochet; mm = millimeters; sc = single crochet; st(s) = stitch (es); yo = yarn over; [] = work directions in brackets the number of times specified.





LW3346



knitting
Designed by Lorna Miser

What you will need:

RED HEART® Anne Geddes

Baby™: 1 ball each 902 Ladybug A, 112 Night-night-B and 100 Lily C.

Susan Bates® Knitting Needles:
3.5mm [US 4]

Stitch markers, yarn needle

GAUGE: 21 sts = 4" [10 cm]; 32 rows = 4" [10 cm] in St.st. **CHECK YOUR GAUGE. Use any size needles to obtain the gauge.**



 RED HEART® Anne Geddes Baby™, Art. 805 available in solid 3.5 oz (100 g) 340 yd (310 m) and multi 3.5 oz (100 g) 290 yd (265 m)



Please Note: Print this pattern using Landscape Orientation.

Find more ideas & inspiration: www.redheart.com and www.crochettoday.com

©2013 Coats & Clark



Sweet Lady Bug Booties

Keep a little one's feet cozy in these ever-so-cute lady bug booties. Knit them to wear with any outfit, or create our matching Lady Bug Jacket and Hat for a complete picture-perfect ensemble, LW3345.

Booties measure 4" [10 cm] long

BOOTIES

With A, cast on 28 sts.

Work in St st for 3½" [9 cm] from beginning, end with a wrong side row.

Cut A and join B. Work 2 rows in St st.

Shape Toe

Row 1 (Right Side): *K2, k2tog; repeat from * across – 21 sts.

Row 2: Purl.

Row 3: *K1, k2tog; repeat from * across – 14 sts.

Row 4: Purl.

Row 5: [K2tog] 7 times – 7 sts.

Cut yarn, leaving a long tail. Thread tail through remaining sts and pull to close. Knot to secure.

FINISHING

Sew 2½" [6.4 cm] from toe closed along edge.

Cuff

With right side facing, join C at last st of first row, pick up and knit 28 sts along edge of Ankle to first st of first row.

Knit 3 rows.

Bind off.

Fold cast-on edge in half and sew closed for back seam.

Using B, embroider a line up the center of foot in chain st. Work French knots randomly on either side of chain sts for ladybug spots.

Weave in ends.

The Revised (2012) Pattern & Information Book

I've encountered some confusion about Care Wear patterns. Some participants on the mailing list for the quarterly newsletter thought that all of our patterns were distributed via the newsletter and they thought that the newsletter patterns were not complete. **Agreed!** The quarterly newsletter is used to supplement the basic collection of patterns for Knit, Crochet, and Sewing found in the Pattern & Information Book & on the website (www.carewear.org).

If you do not have access to the Pattern & Information Book (pdf file) on the website, please request a hardcopy. I have copies available. The request for a donation of \$5 to cover postage & printing is for those who are able to make a donation. If not, don't worry about the donation!

Abbreviations

A, B, C = Color A, B, C; k = knit; k2tog = knit 2 sts together; mm = millimeters; St st = Stockinette stitch; st(s) = stitch(es); tog = together; [] = work directions in brackets the number of times specified; * or ** = repeat whatever follows the * or ** as indicated.



LW3716



crochet

Designed by Michele Wilcox

What you will need:

RED HEART® Anne Geddes Baby™: 1 ball of 100 Lily

Susan Bates® Crochet Hook: 3.5mm [US E-4]

Yarn needle

GAUGE: Gauge is not critical for this project.

Buy Yarn



RED HEART® Anne Geddes Baby™ Art.

E805 available in solid 3.5 oz (100 g) 340 yd (310 m) and multi 3.5 oz (100 g) 290 yd (265 m) balls



A to Z in Crochet

Use these crocheted alphabet letters to personalize or send a message on your creations. Each letter is two inches tall and can be sewn or applied with fabric glue.

Each Letter measures 2" [5 cm] tall

LETTERS

A

Ch 8.

Row 1: Sc in 2nd ch from hook and in next 3 ch, ch 3, sc in 2nd ch from hook and in next ch for center bar, sc in next 3 ch of ch-8, turn, ch 4, slip st in tip of center bar, ch 5, turn, sc in 2nd ch from hook and next 3 ch, sc in slip st, sc in last 4 ch, slip st in first st. Fasten off, leaving a long tail for sewing.

B

Ch 8.

Row 1: Sc in 2nd ch from hook and in each ch across - 7 sc.

Row 2: Ch 5, turn, skip 3 sc, sc in next sc, ch 6, skip next 2 sc, slip st in last sc.

Row 3: Turn, skip slip st, sc in next 6 ch, slip st in sc, sc in last 5 ch, slip st in edge of Row 1. Fasten off, leaving a long tail for sewing.

C

Ch 13.

Row 1: Sc in 2nd ch from hook and in each ch across - 12 sc.

Fasten off, leaving a long tail for sewing. Shape into a "C" while sewing in place.

D

Ch 17.

Row 1: Sc in 2nd ch from hook and in next 6 ch, 3 sc in next ch, sc in next 7 ch, 2 sc in last ch, slip st in first st to join.

Fasten off, leaving a long tail for sewing.

E

Ch 8.

Row 1: Slip st in 2nd ch from hook, [ch 3, sc in 2nd ch from hook, sc in next ch, sc in next 3 ch of ch-8] twice, ch 3, sc in 2nd ch from hook, sc in next ch, slip st in side of last sc

along ch-8.

Fasten off, leaving a long tail for sewing.

F

Ch 8.

Row 1: Sc in 2nd ch from hook and in next 3 ch, ch 3, sc in 2nd ch from hook, sc in next ch, sc in next 3 ch of ch-8, ch 3, sc in 2nd ch from hook, sc in next ch, slip st in last ch. Fasten off, leaving a long tail for sewing.

G

Ch 15.

Row 1: Slip st in 2nd ch from hook, ch 3, sc in 2nd ch from hook, sc in next ch, slip st in same space as slip st, sc in remaining 13 ch. Fasten off, leaving a long tail for sewing. Shape into a "G" while sewing in place.

H

Left Side

Ch 8.

Row 1: Sc in 2nd ch from hook and in next 3 ch, ch 3, sc in 2nd ch from hook, sc in next ch for center bar, sc in next 3 ch of ch-8. Fasten off, leaving a long tail for sewing.

Right Side

Ch 8.

Row 1: Sc in 2nd ch from hook and in next ch across - 7 sc.

Fasten off, leaving a long tail for sewing.

Sew Sides together along center bar.

I

Ch 8.

Row 1: Sc in 2nd ch from hook and in each ch across - 7 sc.

Fasten off, leaving a long tail for sewing.

Continued...



Please Note: Print this pattern using Landscape Orientation.

Find more ideas & inspiration: www.redheart.com and www.crochettoday.com

©2013 Coats & Clark

J

Ch 10.
Row 1: Sc in 2nd ch from hook and in each ch across, ch 3, sc in 2nd ch from hook, sc in next ch, sc in side of last sc along ch-10, ch 3, sc in 2nd ch from hook, sc in next ch, slip st in same sc alongside.
 Fasten off, leaving a long tail for sewing.
 Shape into a "J" while sewing in place.

K

Ch 8.
Row 1: Sc in 2nd ch from hook and in next 3 ch, ch 5, sc in 2nd ch from hook, sc in next 3 ch, slip st in last sc along ch-8, ch 4, sc in 2nd ch from hook, sc in next 2 ch, slip st in same sc alongside, sc in remaining ch of ch-8.
 Fasten off, leaving a long tail for sewing.

L

Ch 12.
Row 1: Sc in 2nd ch from hook and in next 2 ch, skip next ch, sc in last 7 ch.
 Fasten off, leaving a long tail for sewing.

M

Ch 21.
Row 1: Sc in 2nd ch from hook and in next 9 ch, ch 5, sc in 2nd ch from hook, sc in next 3 ch, ch in remaining 10 ch of ch-21.
 Fasten off, leaving a long tail for sewing.
 Shape into a "M" while sewing in place.

N

Ch 25.
Row 1: Sc in 2nd ch from hook and in next 6 ch, skip next ch, sc in ch in next 8 ch, skip 1 ch, sc in each remaining ch across.
 Fasten off, leaving a long tail for sewing.
 Shape into a "N" while sewing in place.

T

Ch 8.
Row 1: Sc in 2nd ch from hook and in each ch across, ch 3, sc in 2nd ch from hook, sc in next ch, sc in side of last sc along ch-8, ch 3, sc in 2nd ch from hook, sc in next ch, slip st in same sc alongside.
 Fasten off, leaving a long tail for sewing.

U

Ch 17.
Row 1: Sc in 2nd ch from hook and in each ch across - 16 sc.
 Fasten off, leaving a long tail for sewing.
 Shape into a "U" while sewing in place.

V

Ch 18.
Row 1: Sc in 2nd ch from hook and in next 7 ch, skip next ch, sc in remaining 8 ch.
 Fasten off, leaving a long tail for sewing.
 Shape into a "V" while sewing in place.

W

Work as for M, reversing direction while sewing in place.

X

Make 2
 Ch 8.
Row 1: Sc in 2nd ch from hook and in each ch across - 7 sc.
 Fasten off, leaving a long tail for sewing.
 Shape pieces into a "X", crossing in center, while sewing in place.

Y

Row 1: [Ch 5, sc in 2nd ch from hook and in next 3 ch] twice, slip st in first ch, ch 5, sc in 2nd ch from hook and in next 3 ch, slip st in same slip st.
 Fasten off, leaving a long tail for sewing.

O

Ch 17, slip st in first ch to join.
Row 1: Sc in each ch around, slip st in first sc.
 Fasten off, leaving a long tail for sewing.

P

Ch 8.
Row 1: Sc in 2nd ch from hook and in each ch across - 7 sc.
Row 2: Ch 5, turn, skip first 3 sc, slip st in next sc, leave remaining sts unworked.
Row 3: Turn, sc in each ch of ch-5, slip st in last ch.
 Fasten off, leaving a long tail for sewing.

Q

Ch 17, slip st in first ch to join.
Row 1: Ch 3, sc in 2nd ch from hook and in next ch, sc in each ch around, slip st in first ch, ch 3, sc in 2nd ch from hook and next ch.
 Fasten off, leaving a long tail for sewing.

R

Ch 8.
Row 1: Sc in 2nd ch from hook and in each ch across - 7 sc.
Row 2: Ch 5, turn, skip 3 sc, sc next sc for center sc, ch 5, turn, sc in 2nd ch from hook and next 3 ch, slip st in center sc, sc in 4 ch of first ch-5 space, slip st in edge of Row 1.
 Fasten off, leaving a long tail for sewing.

S

Ch 17.
Row 1: Sc in 2nd ch from hook and in each ch across - 16 sc.
 Shape into a "S" while sewing in place.

Z

Ch 16.
Row 1: Sc in 2nd ch from hook and in next 3 ch, skip next ch, sc in next 5 ch, skip next ch, sc in remaining 4 ch.
 Fasten off, leaving a long tail for sewing.
 Shape into a "Z" while sewing in place.

FINISHING

Weave in ends.

Abbreviations

ch = chain; mm = millimeters; sc = single crochet; st(s) = stitch(es); tog = together; [] = work directions in brackets the number of times specified; * or ** = repeat whatever follows the * or ** as indicated.

Hello Bonnie,
 I just wanted to thank you for the wonderful donation to our facility, our residents love the bags and they are helpful to them.
 Have a wonderful day!!
 Clair Butler, RN, ADNS
 Heartland of Springfield
 937-390-0005
 937-390-6482 Fax
 CLAIR.BUTLER@HCR-MANORCARE.COM



LW3294



Knitting

Design by Nancy J. Thomas

What you will need:

RED HEART® Anne Gaddes Baby™, 1 ball 801 Bluebell

Susan Bates® Double Pointed Knitting Needles: 4 mm [US 6]

Marker, yarn needle

GAUGE: 22 sts = 4" (10 cm), 32 rows = 4" (10 cm) in block pattern. **CHECK YOUR GAUGE.** Use any size needles to obtain the gauge.

Buy Yarn



RED HEART® Anne Gaddes Baby™, Art.

805 available in solid

3.5 oz (100 g) 340 yd (310 m) and multiples 3 oz (85 g) 290 yd (265 m)



Basketweave Hat

Here's a comfy knit hat for girl and boy babies. It can be made to match any outfit, thanks to the many bright and softer colors that are available in this yarn. Perfect to give for baby's shower or when the new little person arrives.

Directions are for size 6-9 month; changes for 12-18 month are in parentheses

Finished Size

13" (14") [33 [35.5] cm] circumference

HAT

RIBBING

Cast on 72 (84) sts, evenly across double pointed needles. Join, being careful that sts are not twisted, and begin working in the round. Place marker for beginning of round.

Round 1 (Right side): (K2, P2) around.

Repeat Round 1 for pattern until Ribbing measures approximately 1" (2.5 cm) from cast on edge.

BODY

Rounds 1 and 2: Knit around.

Rounds 3-8: (K4, P4) around.

Rounds 9-14: (P4, K4) around.

Rounds 15-26: Repeat Rounds 3-14 one time.

Round 27: Knit around.

CROWN

Round 1: (K2 tog, K 10) around: 66 (77) sts.

Round 2: (K2 tog, K9) around: 60 (70) sts.

Round 3: (K2 tog, K8) around: 54 (63) sts.

Round 4: (K2 tog, K7) around: 48 (56) sts.

Round 5: (K2 tog, K6) around: 42 (49) sts.

Round 6: (K2 tog, K5) around: 36 (42) sts.

Round 7: (K2 tog, K4) around: 30 (35) sts.

Round 8: Knit around.

Size 6-9 Months Only

Round 9: K2 tog around: 15 sts.

Size 12-18 Months Only

Round 9: K2 tog around to last st, K1: 18 sts.

All Sizes

Round 10: Knit around.

Round 11: (K2 tog, K1) around: 10 (12) sts.

Round 12: Knit around.

Round 13: K2 tog around: 5 (6) sts.

FINISHING

Cut yarn, leaving a 12" (30.5 cm) end. Thread yarn needle with end and weave through remaining stitches. Draw up firm; fasten securely.

ABBREVIATIONS

K = knit; mm = millimeter; P = purl; st(s) = stitch(es); tog = together; () = work instructions in parentheses as indicated.



Please Note: Print this pattern using Landscape Orientation.

Find more ideas & inspiration: www.redheart.com and www.crochettoday.com

©2013 Coats & Clark

RedHeart.com

Bonnet for Preemie Gown #2
In March 2013 newsletter

Materials: Sensation Cuddle Muffin Yarn. (or any #3 light)
1/8" ribbon

Needles: Size 5

Abbreviations: yo: yarn over.

Pattern shared by Heather Rinkel. In case of questions, please contact Heather
Heather.Rinkel@yahoo.com
567 Brenna Trail, East Jordan, MI 49727

Cast on 53 stitches.

Rows 1-5 Knit (garter stitch).

Row 6: Knit 3, *K2tog. yo, k.3, repeat from * to end of row.

Row 7: Knit 3, *P2tog. yo, p.3, repeat from * to last 3 sts., yo,K3.

Repeat last 2 rows until work measures 4" inches from cast on, ending with Row 6.

Next row: (Wrong side) Knit, decreasing 1 stitch in middle of row (52 sts).

Shape back:

Row 1: K.20, K2tog.(6 times), K.20. (46 sts.)

Row 2 and all wrong side rows: KNIT.

Row 3: K.17, K2tog.(6 times) K.17. (40 sts.)

Row 5: K.14, K2tog (6 times), K.14 (34 sts.)

Row 7: K.11, K2tog.(6 times), K.11 (28 sts.)

Row 9: K.8, K2tog.(6 times), K.8 (22 sts.)

Row 11: K.5, K2tog.(6times), K.5` (16 sts.)

Bind off remaining stitches loosely or use 3-needle bind off..

Run a ribbon through the bottom edge of bonnet. The garter stitch edge around the face can be turned back and the ribbon will keep it in place, or it can be left down. This allows some adjustment in size.



Shirt Protectors (bibs) for disabled children

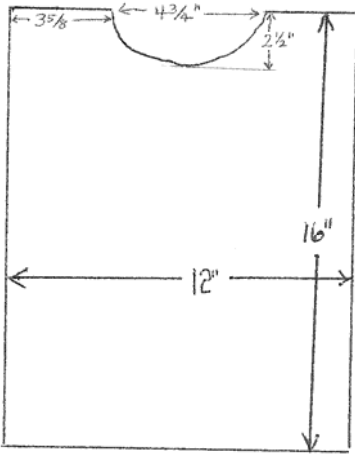

Size Medium: 12" x 16"

Size Large 14" x 19"

Supplies:

Top fabric

Bottom fabric

Batting or toweling or mattress padding

2 15" twill tape or double fold bias tape for ties.

Directions: Put right sides together, batting on top & ties between the two sides. Sew together leaving about 3" open to turn. Sew opening closed & quilt top.

Thanks to Elaine Quetschenbach for sending this pattern with instructions. Elaine & her group send these bibs to Mary Cariola Center, Rochester, NY. Perhaps there is a school or center for children with disabilities in your area. Maybe make a few as samples to see if they are needed.

Questions? Please contact Heather Rinkel 567 Brenna Trail, East Jordan, MI 49727
Or Heather.rinkel@yahoo.com

**BONNET FOR BURIAL GOWN #1 (ALTBARNABE)
 WHITE GOWN
 DIRECTIONS IN THE MARCH 2013 NEWSLETTER**

**Materials: Bernat Softee Baby (or any #3 light)
 Knitting needles #5.
 1/8" ribbon Gauge: 7 sts.= 1"**

Cast on 59 stitches.

Knit 5 rows (garter stitch).

Row 1: Knit.

Row 2: Knit 3, purl to last sts., Knit 3.

Row 3: Knit.

Row 4: Repeat row 2.

Row 5: Knit 3, *with yarn in front, slip next 5 sts. as if to purl, with yarn in back, knit 3. Repeat from * to end.

Row 6: Knit 3, *purl 5, knit 3, repeat from * to end.

Row 7: Knit 5, *pick up loose yarn from previous row and knit with next stitch, knit 7. Repeat from * to last 6 sts. pick up loose stitch as before and knit with next st, knit 5.

Row 8: Repeat Row 2.

Repeat Rows 1-8 until work measures 3-1/2" approx. ending with Row 7.

Shape back: Repeat Row 2, increasing 1 st. in middle of row (60 sts.)

Row 1: *K.8, K2.tog., repeat from * to end. (54 sts.)

Row 2 and every even row: K.3, purl to last 3 sts., K.3.

Row 3: *K.7, k2.tog., repeat from * to end. (48 sts.)

Row 5: *K.6, K2.tog., repeat from * to end. (42 sts.)

Row 7: *K.5, K2.tog., repeat from * to end. (36 sts.)

Row 9: *K.4, K2.tog., repeat from * to end. (30 sts.)

Row 11: *K.3, K2.tog., repeat from * to end. (24 sts.)

Row 13: *K.2, K2.tog., repeat from * to end. (18 sts.)

Row 15: *K.1, K2.tog. repeat from * to end. (12 sts.)

Row 17: *K2.tog. across. (6 sts.)

Break yarn, leaving a 4" tail. thread tail through remaining stitches and draw up tightly. fasten off securely.

Run ribbon through bottom of bonnet, turning back brim and catching it in ribbon. This allows the brim to be adjusted if desired.



Lap Blankets for Veterans

Veterans use these blankets on their laps or around their shoulders.

Material

- Use soft, washable fabrics, such as flannel, cotton, knit, or fleece.
- Use adult-appropriate prints, preferably in cheerful, happy colors.

Size

- The finished size must be a 45" square.
- Piecing fabrics together (vs. having one continuous square) is fine.

Construction

- Use two layers of fabric (quilted with or without batting) to be sure the blanket is warm.
- If the fabric is warm/heavyweight, one layer of fabric is fine.
- Corners may be rounded (use a large lid or plate as a template) or left square.
- Finish the edges with bias tape, rolled hem (using your serger), double fold hem (for single-layer blankets: turn under ¼", stitch, turn under ¼", and stitch again), or another comparable method.
- For fabrics that don't ravel (such as fleece), no finish is needed.

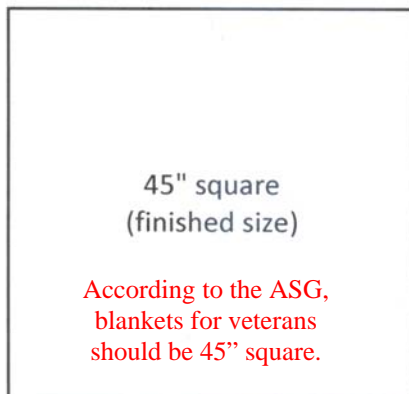

A helpful
guideline from
The American
Sewing Guild's
website
(www.asg.org)



BONNET FOR BURIAL GOWN #1 (striped gown in stocking stitch) MARCH, 2013 Newsletter.

Materials: Sensations Cuddle Muffin yarn (or any #3 light)
Knitting needles #5.
1/8" ribbon.

Cast on 59 stitches.

Knit 5 rows (garter stitch).

Keeping first and last 3 stitches in garter stitch, work in stocking stitch until work measure 3-1/2 - 4 inches from cast on ending with wrong side facing.

Shape back:

Next row: (wrong side): Knit, decreasing 1 stitch in middle of row (58 sts.)

Row 1: Knit 23, (K2tog.) 6 times, Knit 23. (52 sts.)

2nd and all wrong side rows - Knit.

Row 3: Knit 20, (K2tog.) 6 times, Knit 20. (46 sts.)

Row 5: Knit 17, (K2tog.) 6 times, Knit 17. (40 sts.)

Row 7: Knit 14, K2.tog.) 6 times, Knit 14. (34 sts.)

Row 9: Knit 11, (K2tog.) 6 times, Knit 11. (28 sts.)

Row 11: Knit 8, K2tog.) 6 times, Knit 8. (22 sts.)

**Bind off all stitches and sew seam. OR, do 3-needle bind off,
Run ribbon through the bottom of the bonnet.**

Questions? Please contact Heather Rinkel
567 Brenna Trail, East Jordan, MI 49727
Or heather.rinkel@yahoo.com



Receiving Blankets for Babies

These blankets go home with newborns when they leave the hospital.

Material

- Use soft, washable fabrics, such as flannel, cotton, knit, or fleece (please note that fleece may be too warm to use in hot climates).
- Any juvenile print is fine.

Size

- Any size ranging from a 45" square (the width of the fabric made into a square) to a 30" by 36" rectangle (a yard of 60"-width fabric cut in half) is fine.
- Piecing fabrics together (vs. having one continuous square) is fine.

Construction

- Use one layer of fabric in hot climates.
- Use two layers of fabric (quilted with or without batting) in cold climates.
- Corners may be rounded (use a large lid or plate as a template) or left square.
- Finish the edges with bias tape, rolled hem (using your serger), double fold hem (for single-layer blankets: turn under $\frac{1}{4}$ ", stitch, turn under $\frac{1}{4}$ ", and stitch again), or another comparable method.
- For fabrics that don't ravel (such as fleece), no finish is needed.

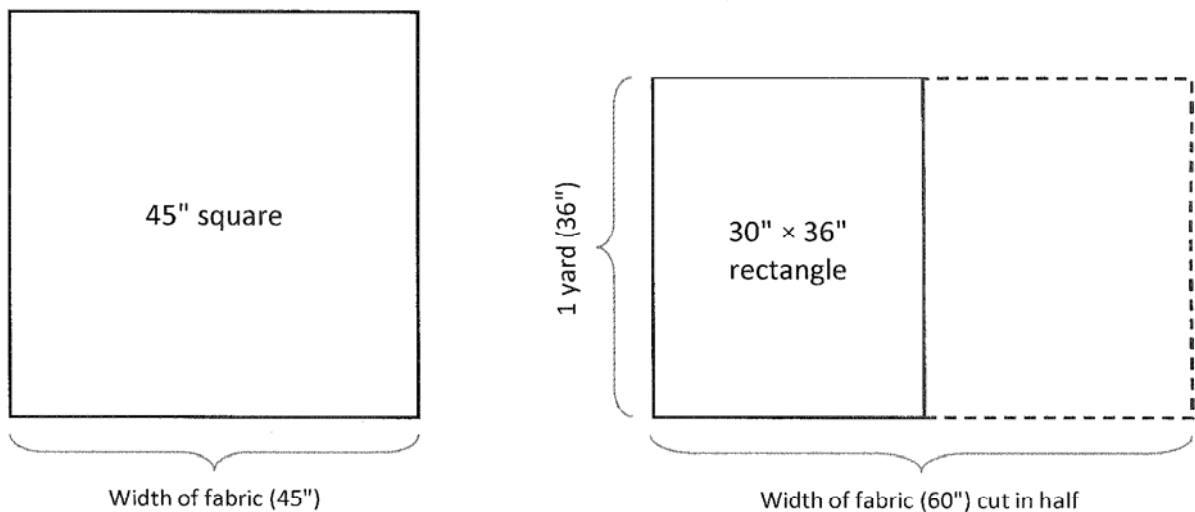

∠ For the babies, the size of the receiving blanket is flexible. We recommend the sizes shown above, but any size that will wrap around a newborn is fine.



Often I am asked for exact measurements for blankets, lap blankets, isolette covers, etc. My best advice is to ask the hospital where you plan to donate completed items. This direction sheet came from The American Sewing Guild's website (www.asg.org) and may be of help as a guideline for starting a project. Make a sample and ask the hospital if the size suits their needs. For receiving blankets, smaller sizes are appropriate for preemies and larger sizes are needed to wrap around larger full-term infants.

Lap Blankets for Hospice Patients

Patients use these blankets on their laps or around their shoulders.



Material

- Use soft, washable fabrics, such as flannel, cotton, knit, or fleece.
- Use adult-appropriate prints, preferably in cheerful, happy colors.

Size

- Any size ranging from a 45" square (the width of the fabric made into a square) to a 30" by 36" rectangle (a yard of 60"-width fabric cut in half) is fine.
- Piecing fabrics together (vs. having one continuous square or rectangle) is fine.

Construction

- Use two layers of fabric (quilted with or without batting) to be sure the blanket is warm.
- If the fabric is warm/heavyweight, one layer of fabric is fine.
- Corners may be rounded (use a large lid or plate as a template) or left square.
- Finish the edges with bias tape, rolled hem (using your serger), double fold hem (for single-layer blankets: turn under $\frac{1}{4}$ ", stitch, turn under $\frac{1}{4}$ ", and stitch again), or another comparable method.
- For fabrics that don't ravel (such as fleece), no finish is needed.

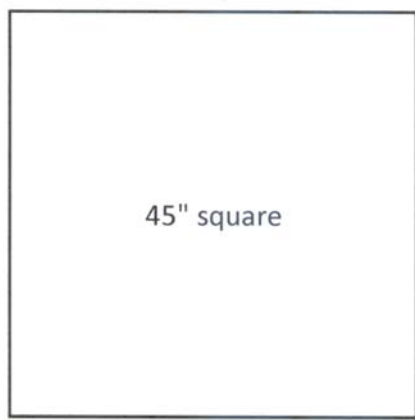

Width of fabric (45")

From The American Sewing Guild website
(www.asg.org) See: Community Service

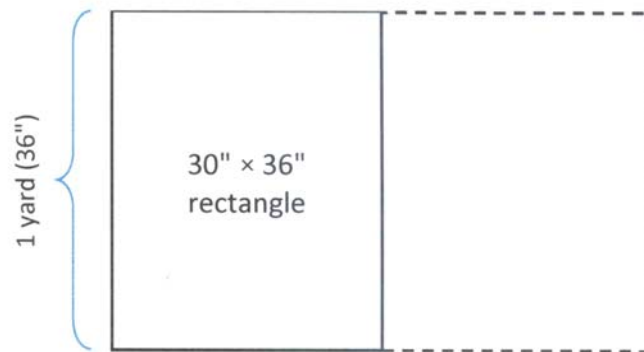

Width of fabric (60") cut in half



For the hospice patients, the size of the blanket is flexible. We recommend the sizes shown above, but any size that will cover a lap is fine.

Yarn: 3 (2 ounce) skeins worsted-weight yarn

Needles: Sizes #3 & #10

Gauge: 5 sts = 1 inch

Note: Entire Shoulderette is worked in ribbing (K1, P1).

With #3 needles cast on 76 sts & work in ribbing (K1, P1) for 2 1/2 inches. Change to #10 needles & work even until piece measures 28 1/2 inches. Change to #3 needles & work 2 1/2 inches. Bind off loosely K as K and P as P.

Finishing: Sew up each side for 2 1/2 inches to form sleeves. Steam lightly.

Shoulderette

Sent by a participant who copied it from "a very old book"



CARE WEAR VOLUNTEERS

Bonnie Hagerman
102 Mercer Court #23-5
Frederick MD 21701-4070

Non-profit org
U.S. Postage
PAID
Frederick, MD
Permit No. 775



I-70 / I-81 REGIONAL COMMUNITY SERVICE GATHERING "SPRING MAKE A DIFFERENCE DAY" (Winchester/Martinsburg/Hagerstown)

If you would be interested in meeting with others from the area for a day of community-service work, Barbara Resan is trying to put together a group in the 4-state area where Virginia, West Virginia, Pennsylvania, & Maryland come together. The purpose would be to share resources, support, & just having a good time together. She is not able to schedule this in the fall, but is looking at a spring date. For planning and for locating a suitable space, she needs to know—as soon as possible—about how many people might attend.

Please contact Barbara if you could attend this event & would like to receive specific details when available. Include your address & telephone number. (Barbara Resan, 877 Redland Road, Whitacre, VA 22625 or 540-888-4551.)